

UABot

Components i cablejat

Punt de partida

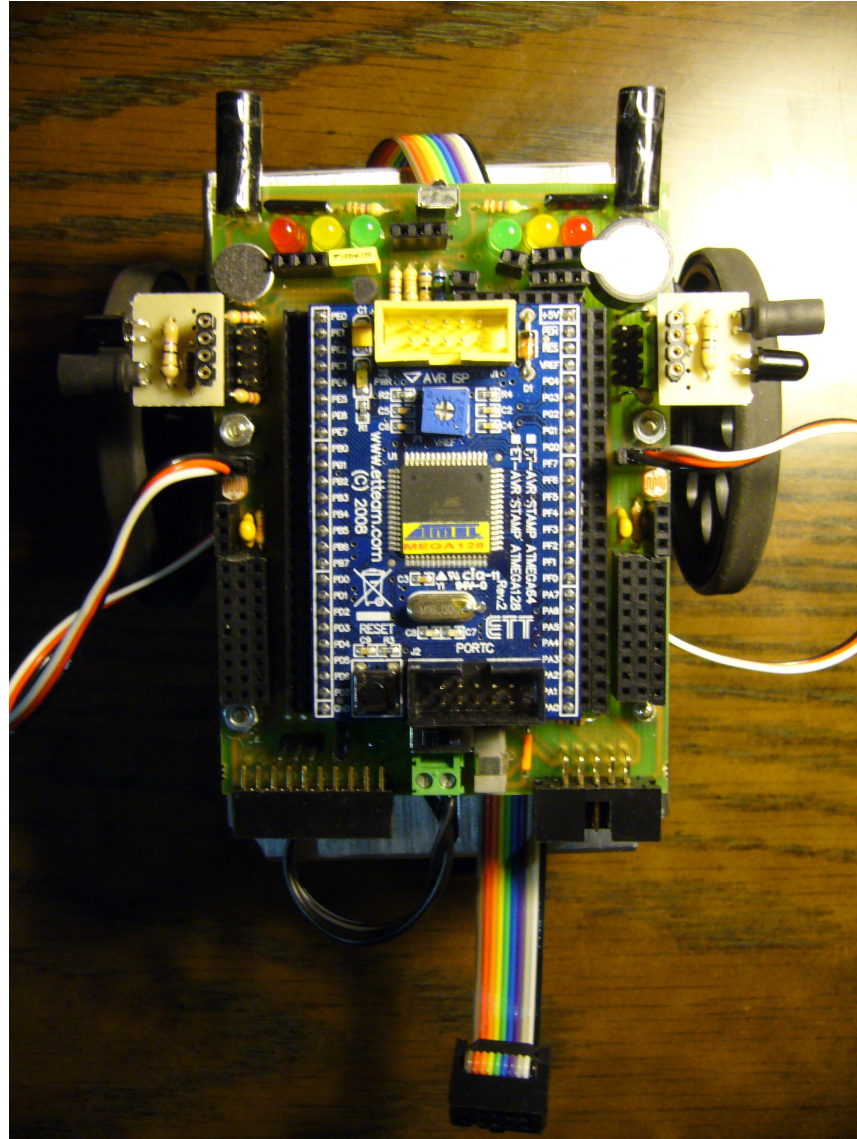

Referències

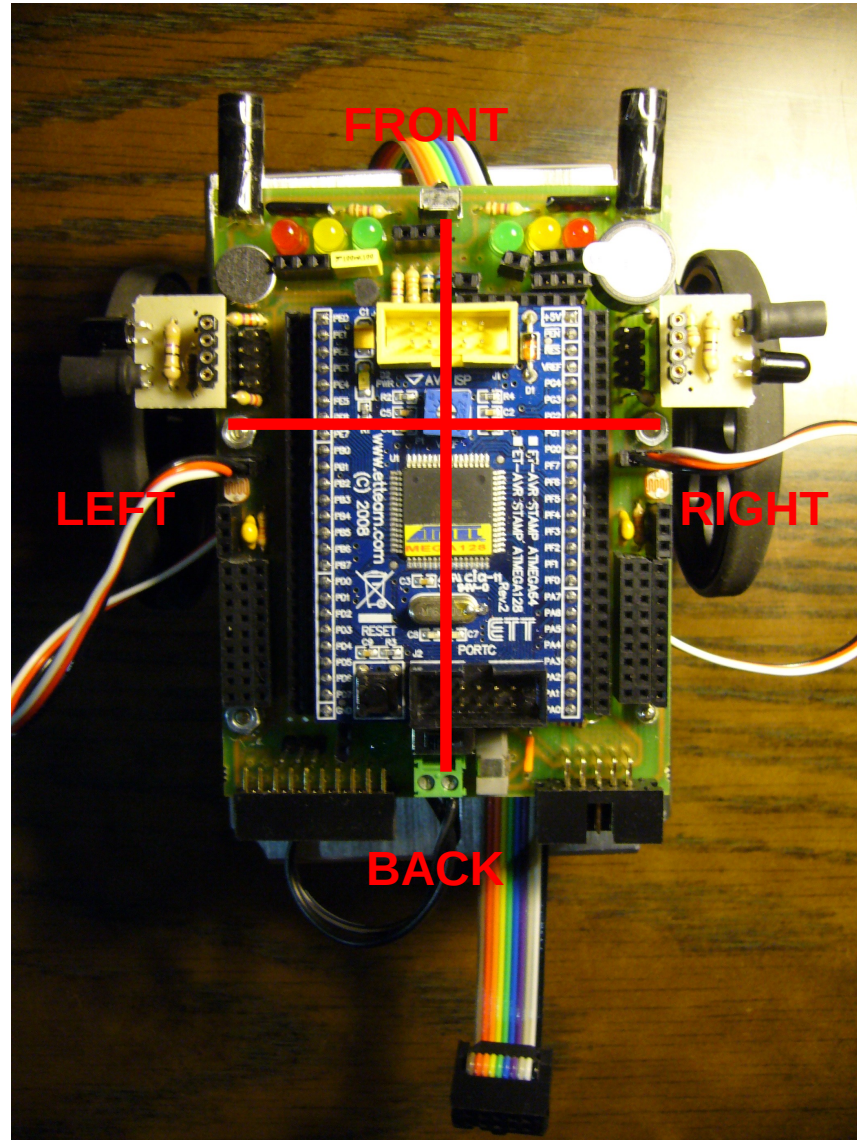

Disposició de la PCB

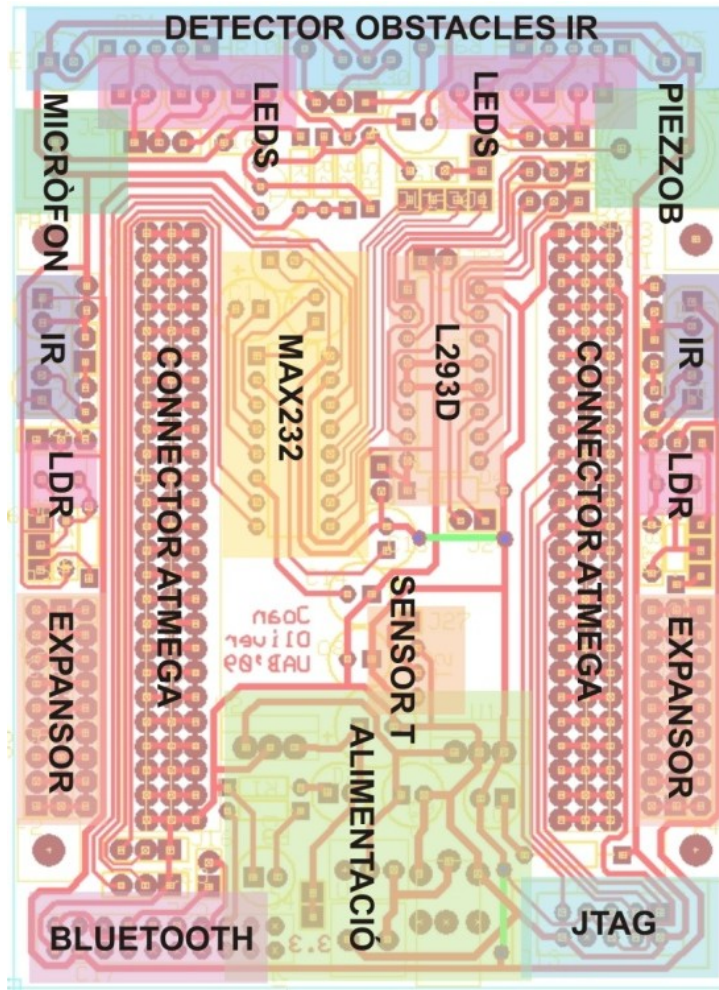

Components

Microcontrolador ATmega128

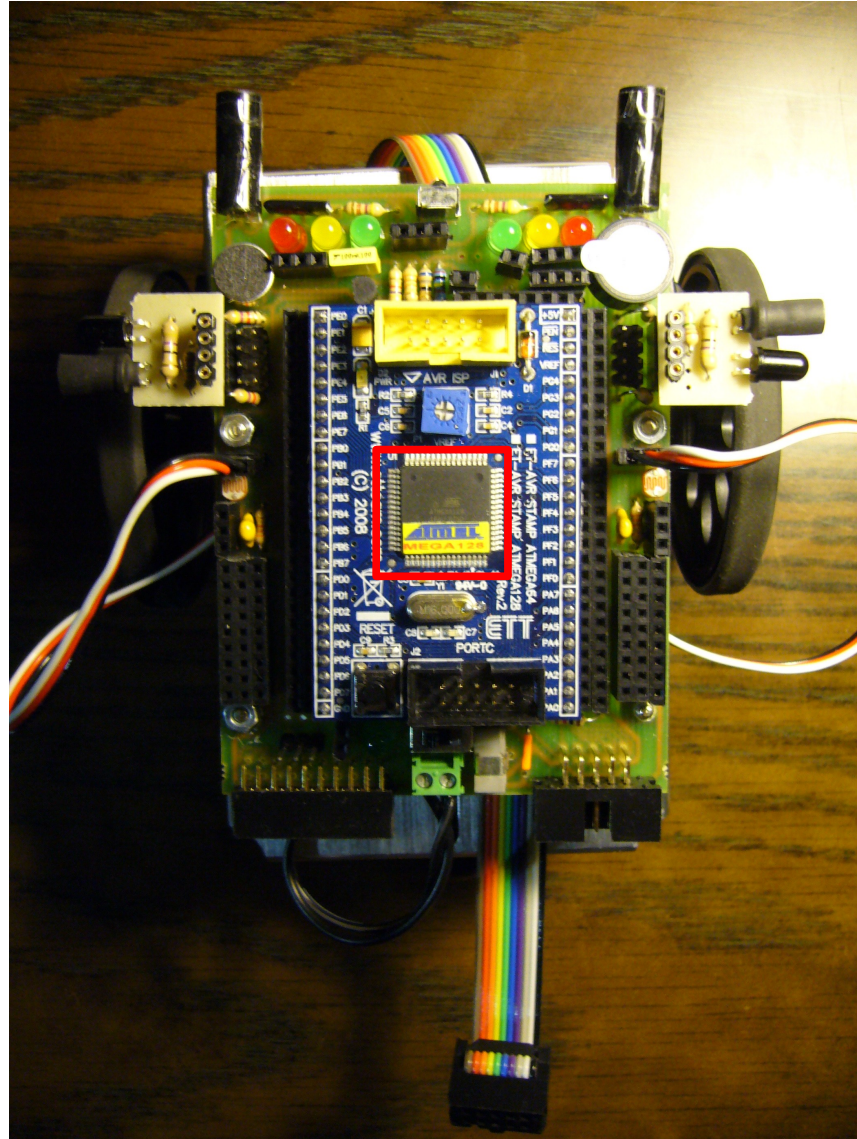

IR Laterals

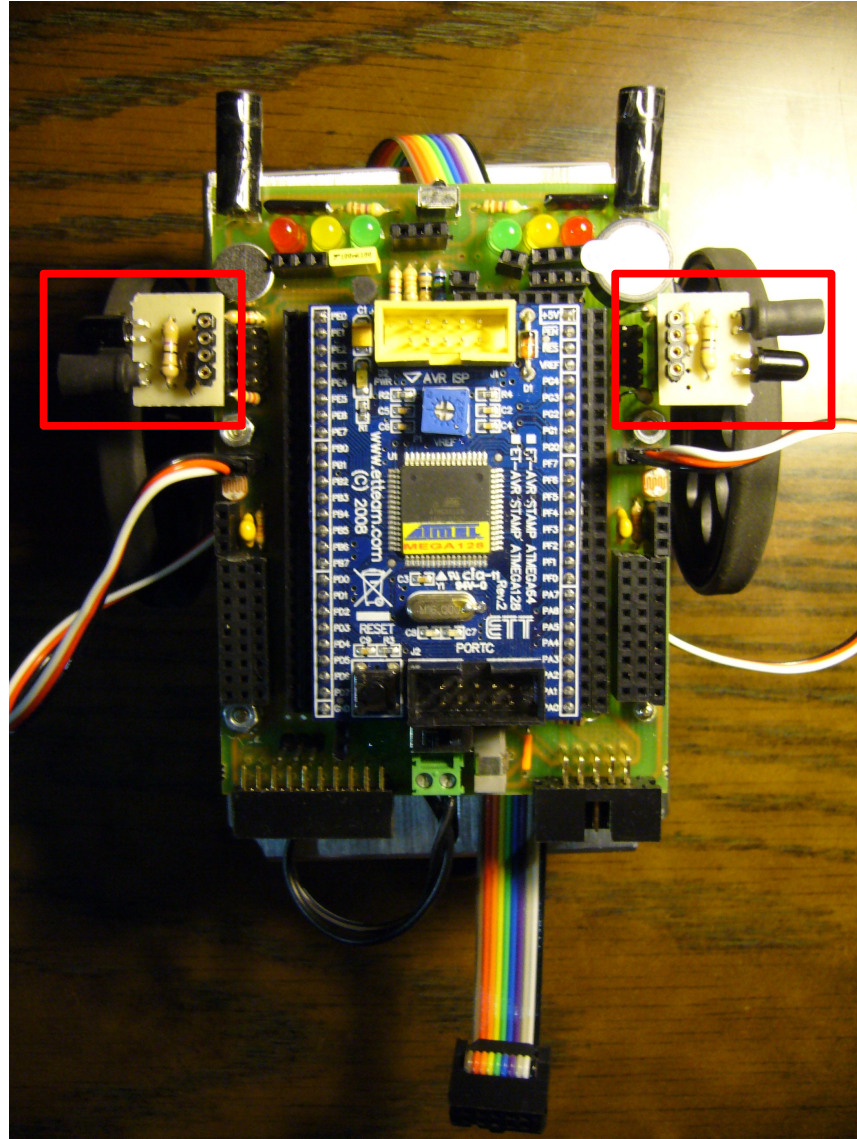

IR Laterals

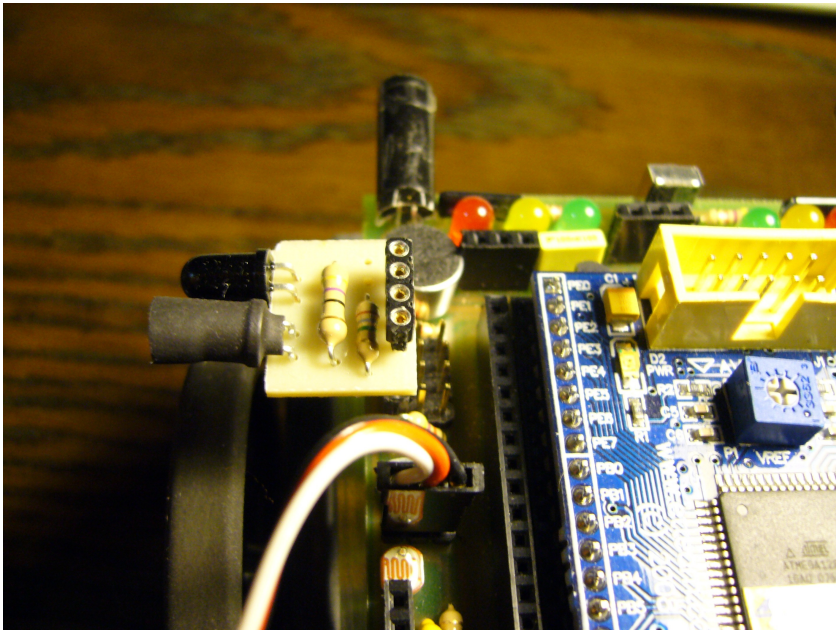

IR Lateral Esquerre

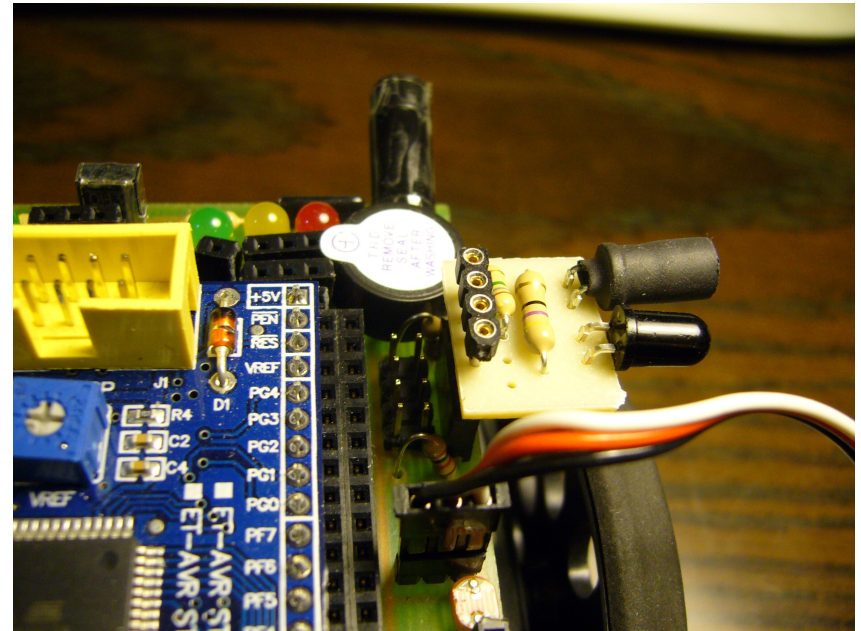

IR Lateral Dret

IR Laterals

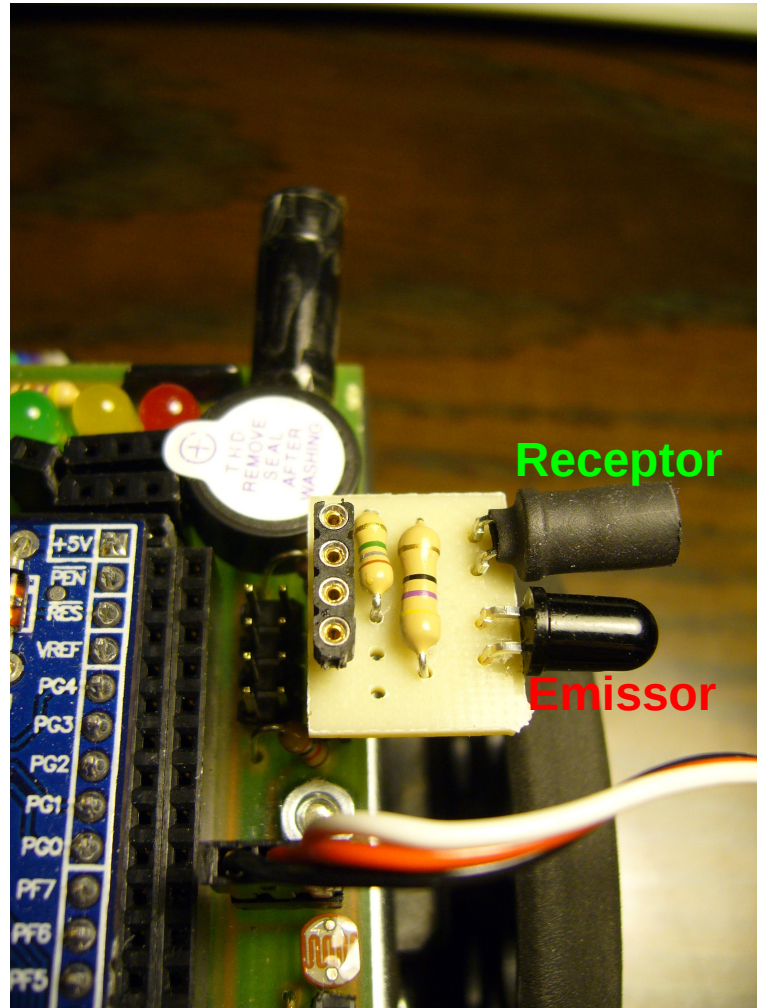

IR Frontal

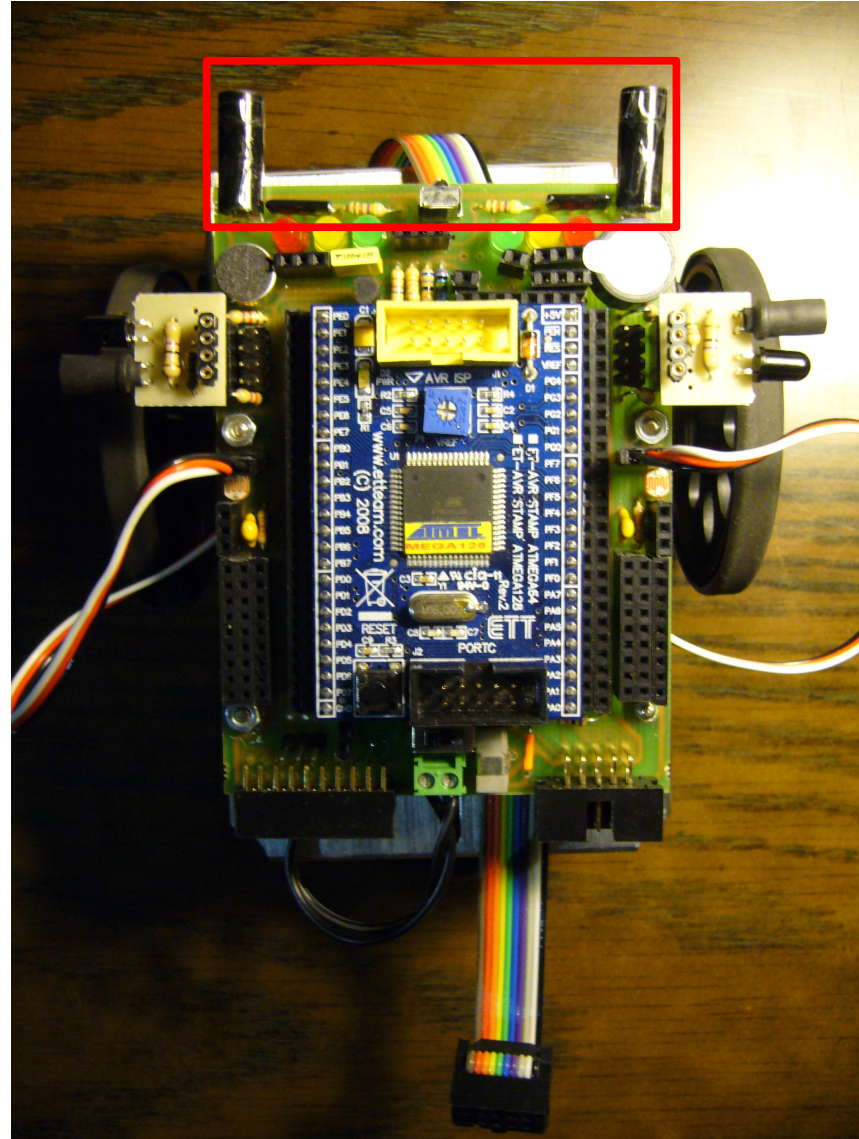

IR Frontal

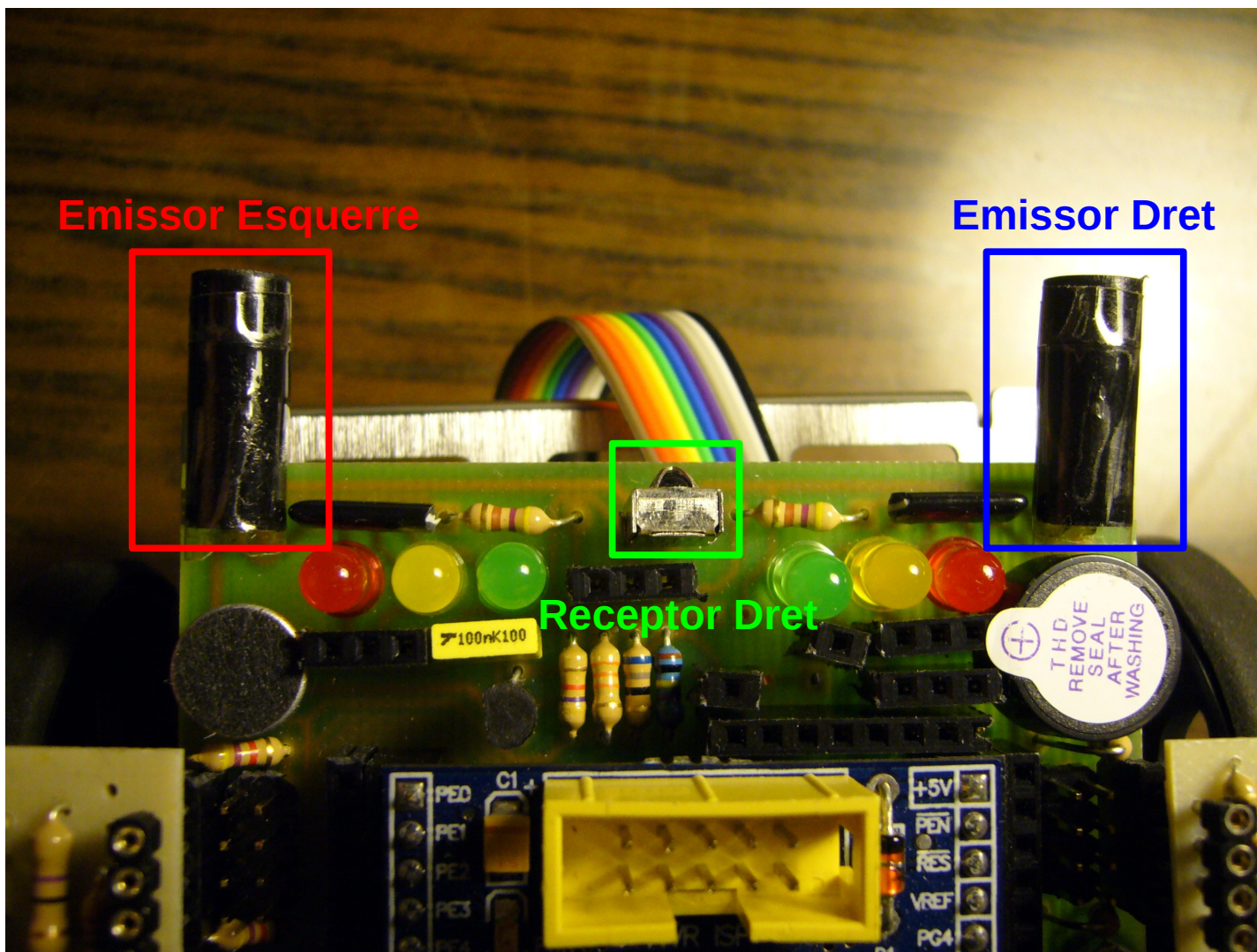

LDRs

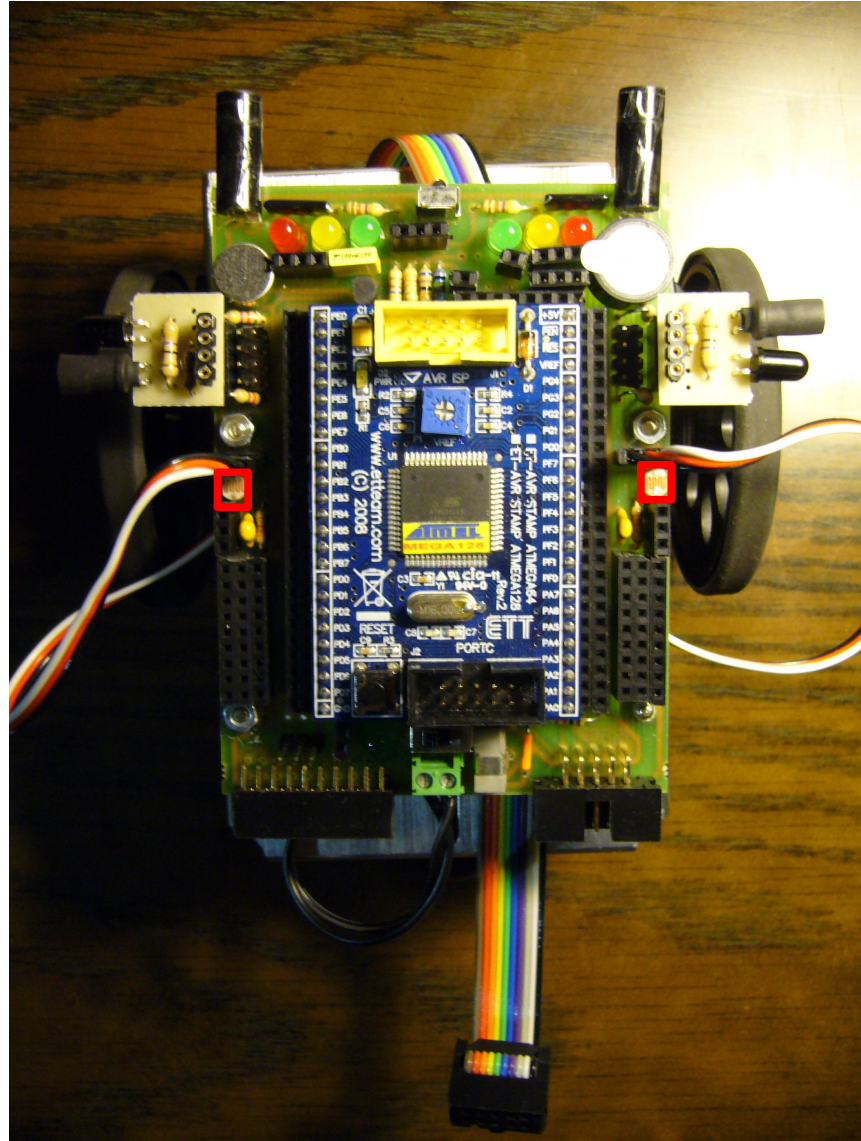

LDR

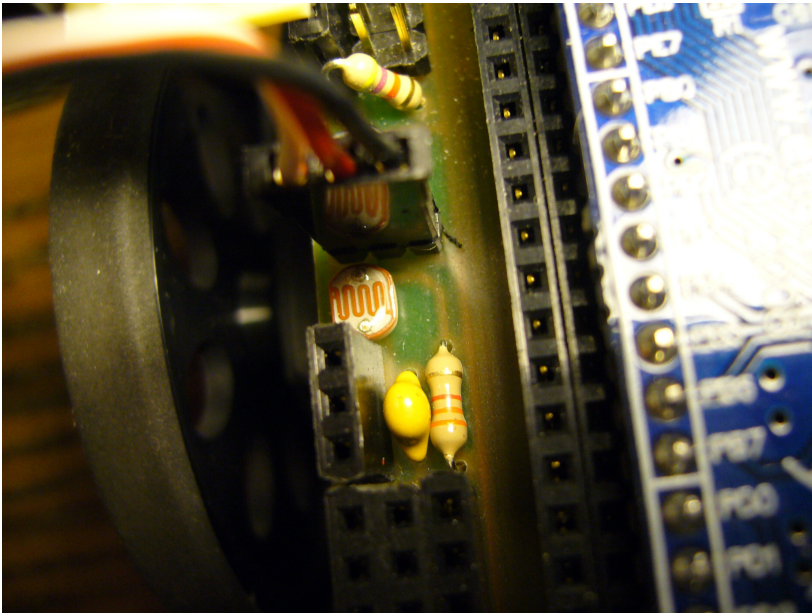

LDR Esquerre

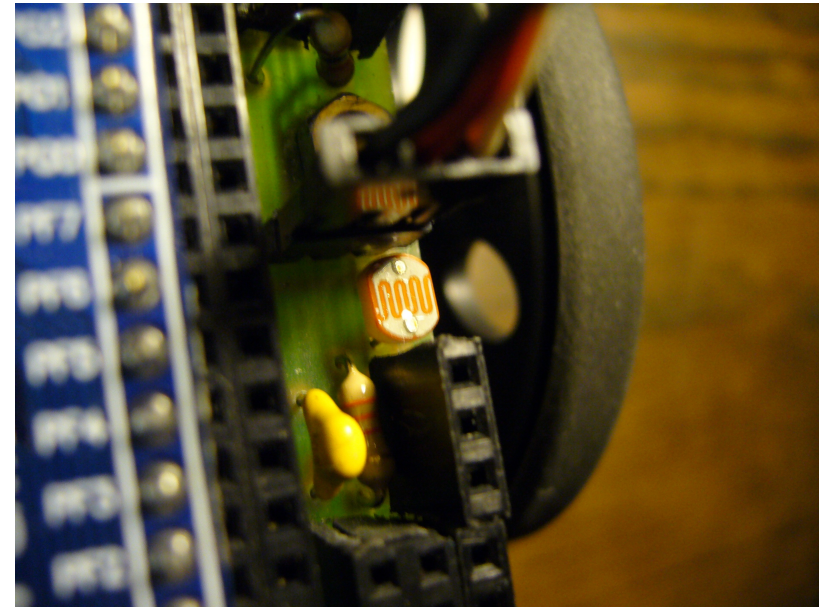

LDR Dret

Senyals PWM

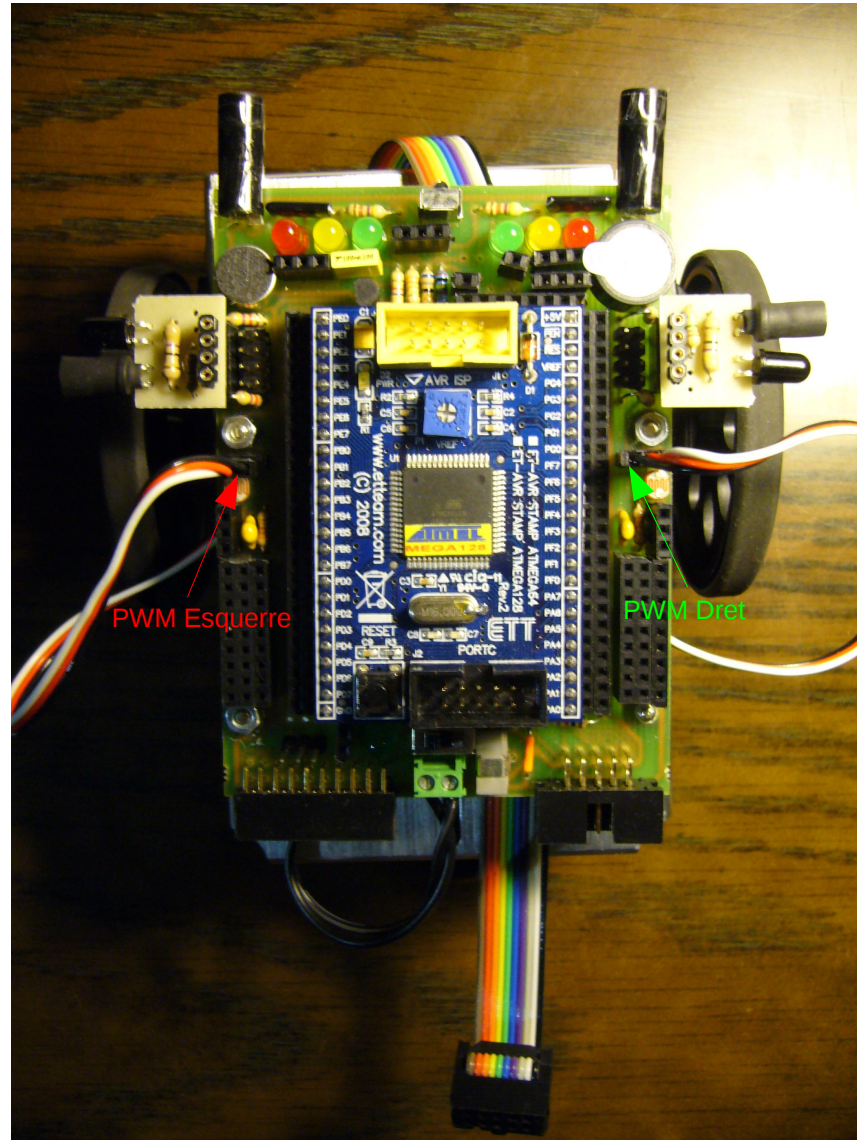

Senyals PWM

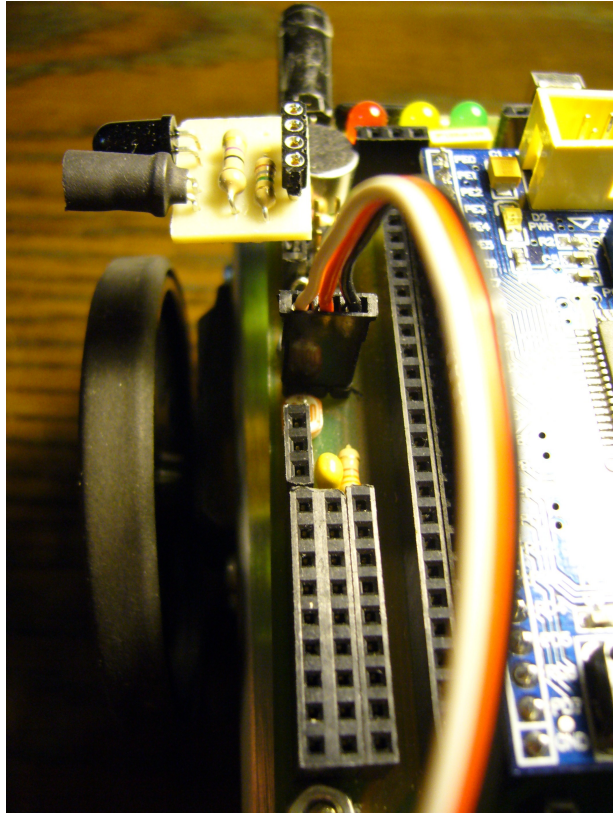

PWM Esquerre

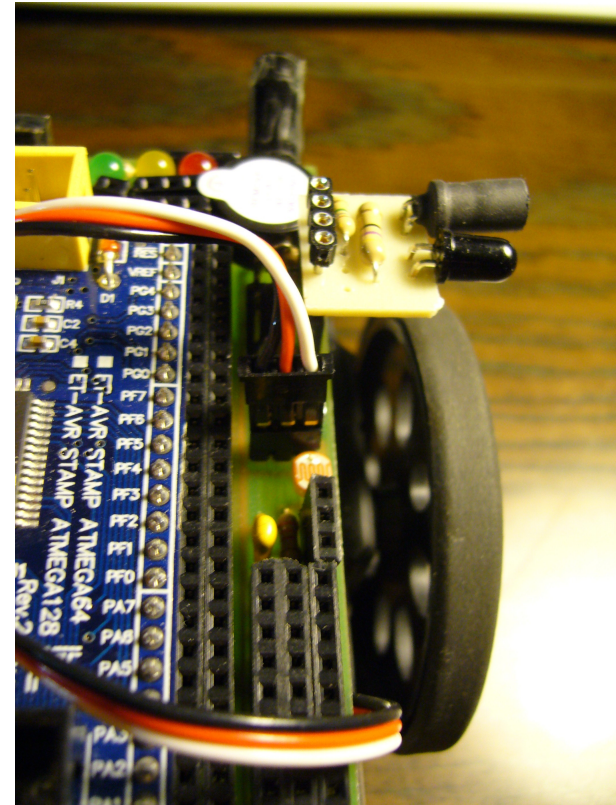

PWM Dret

Senyals PWM

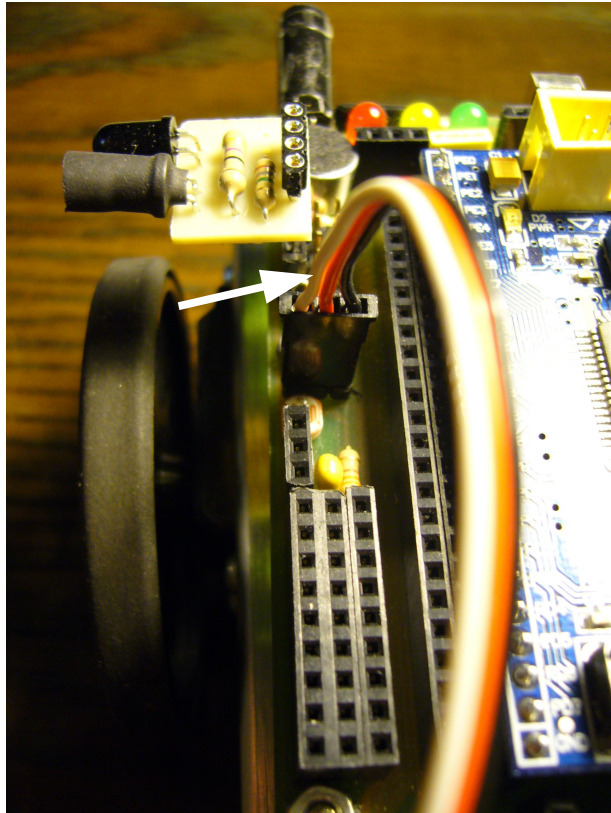

PWM Esquerre

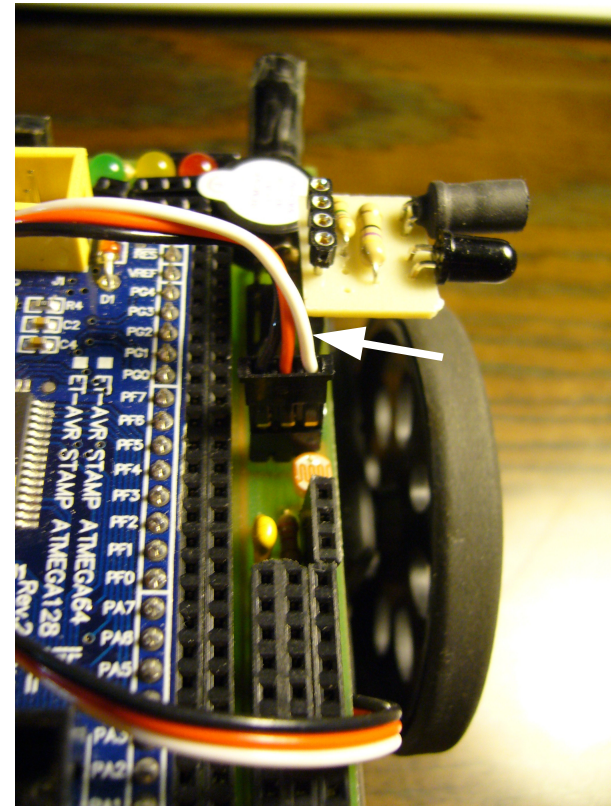

PWM Dret

Micròfon i Piezzo Buzzer

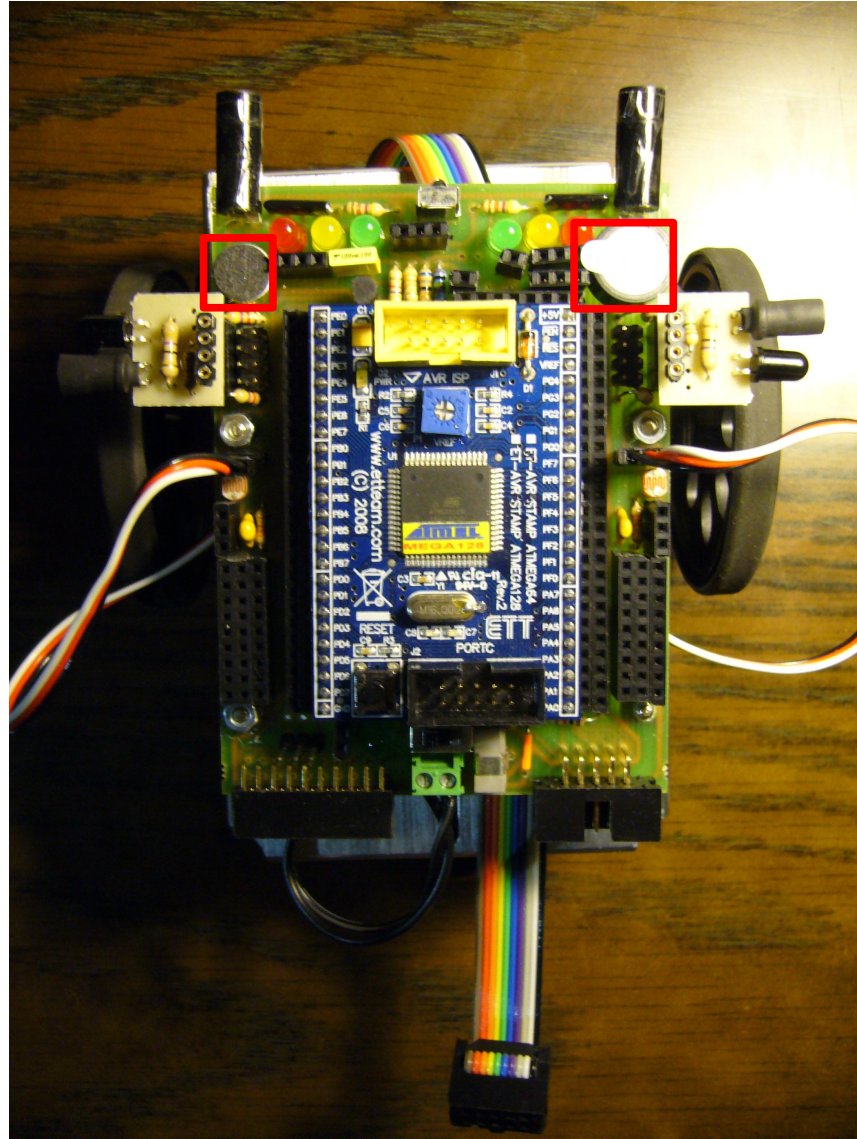

Micròfon i Piezzo Buzzer

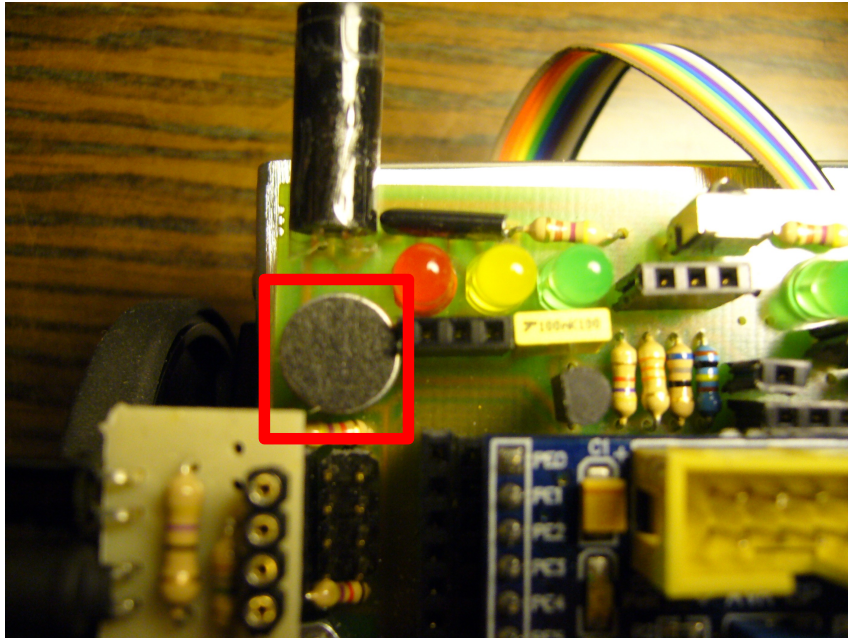

Micròfon

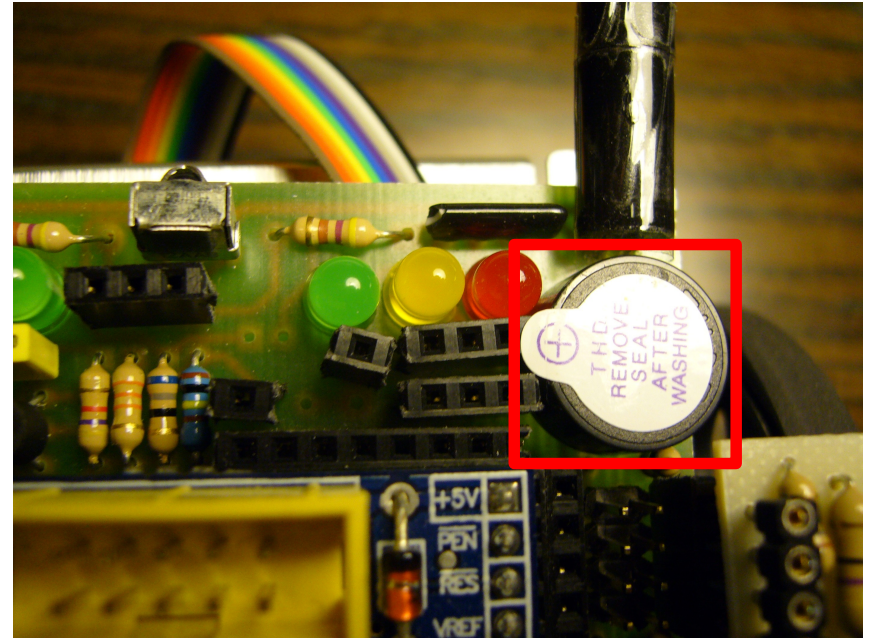

Piezzo Buzzer

Connector seguidor de línea

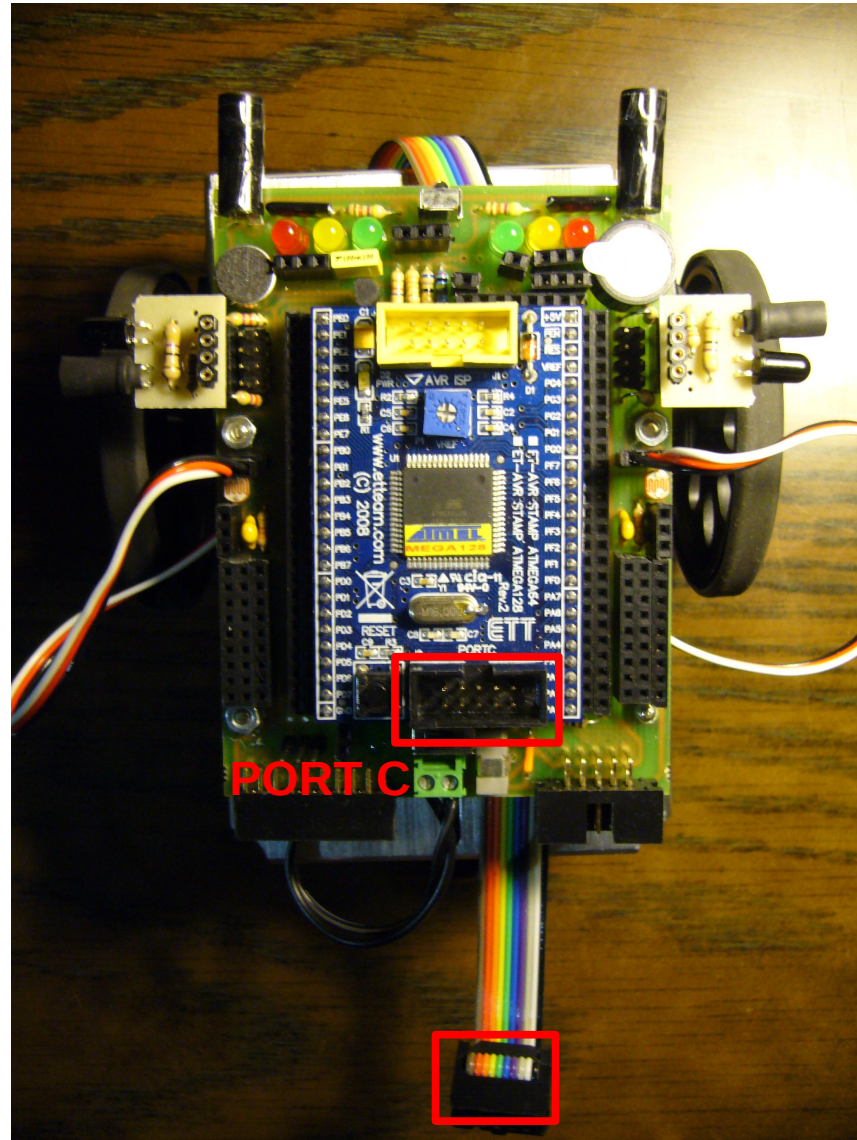

Seguidor de línea



Connector Bluetooth

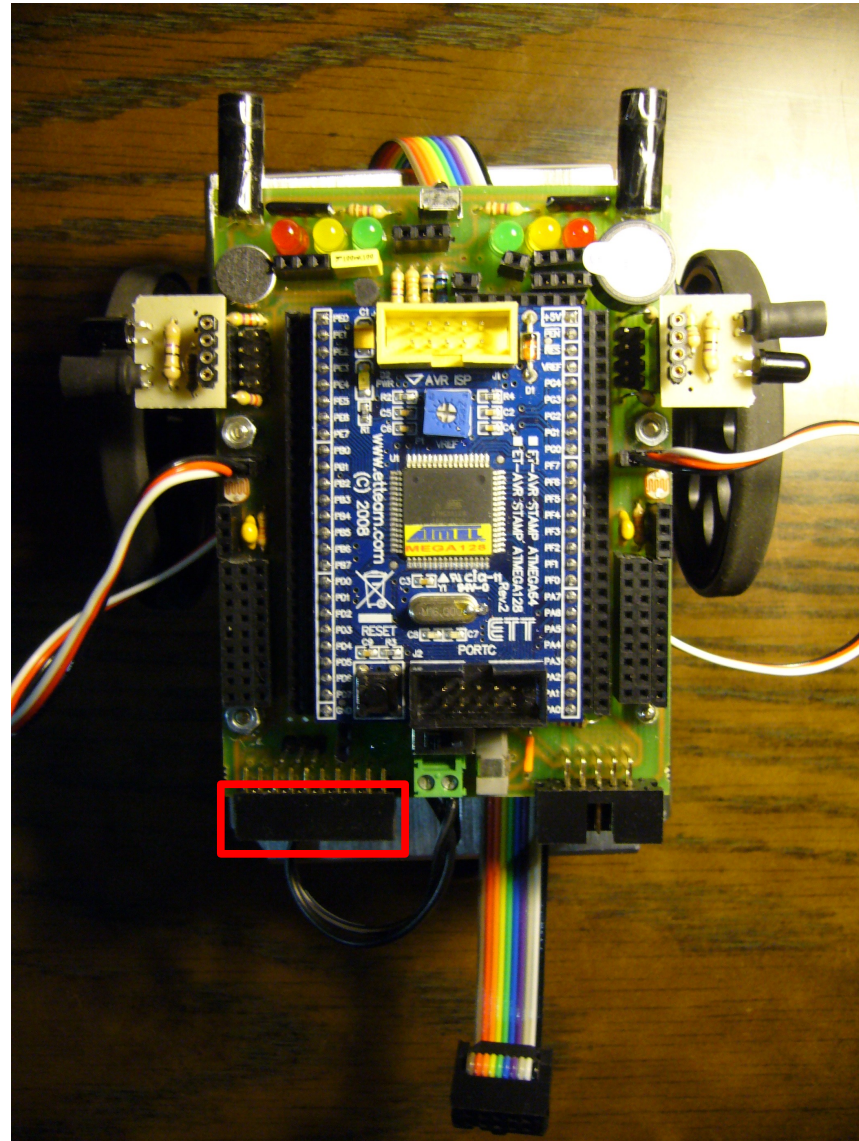

Connector Bluetooth

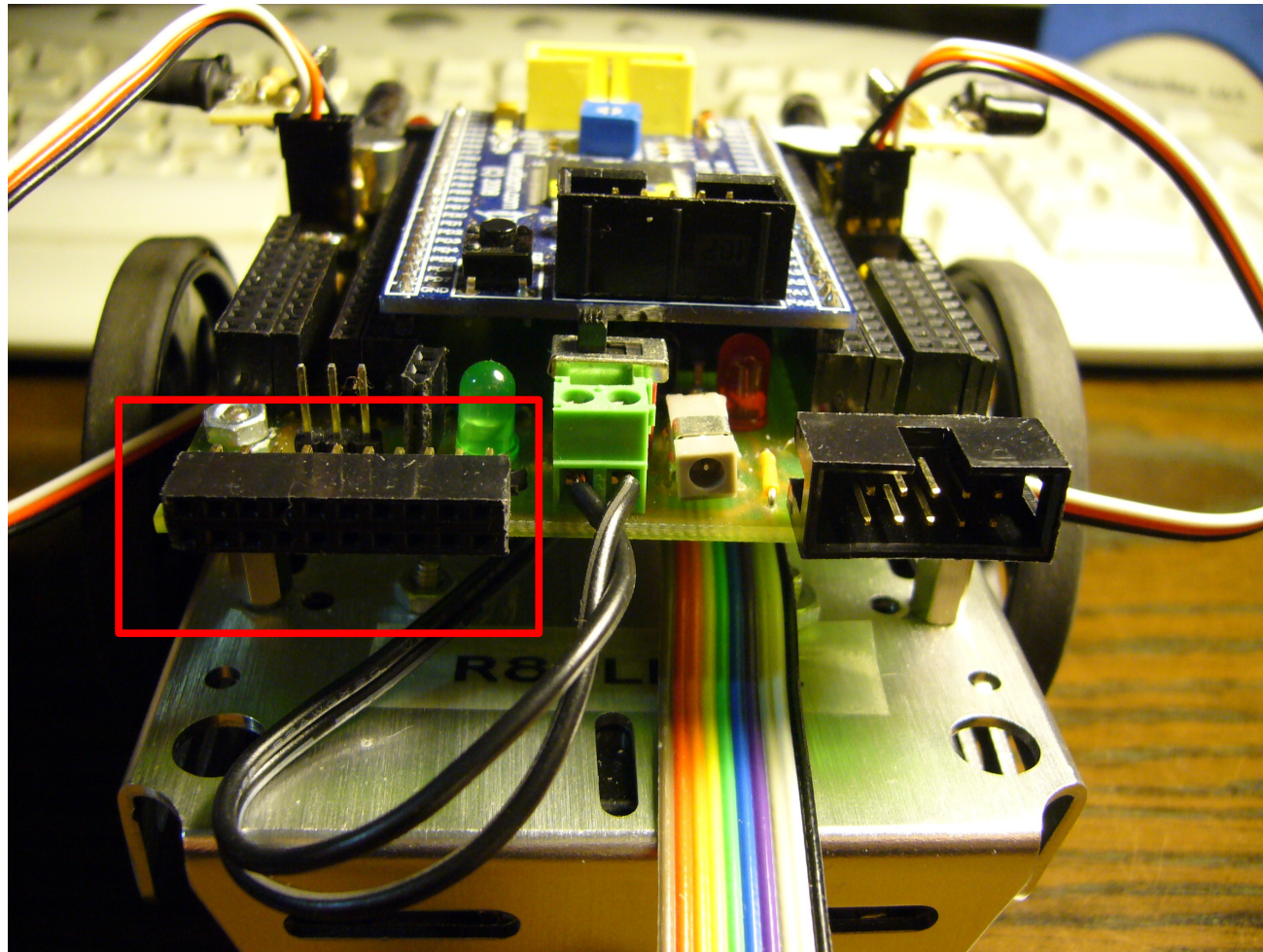



Cablejat

Nomenclatura

Nom

Nomenclatura

Infraroigs Laterals

IRL

Infraroigs Frontals

IRF

Light Dependant Resistor

LDR

Seguidor de Línia

LFW

Micròfon

MIC

Alimentació

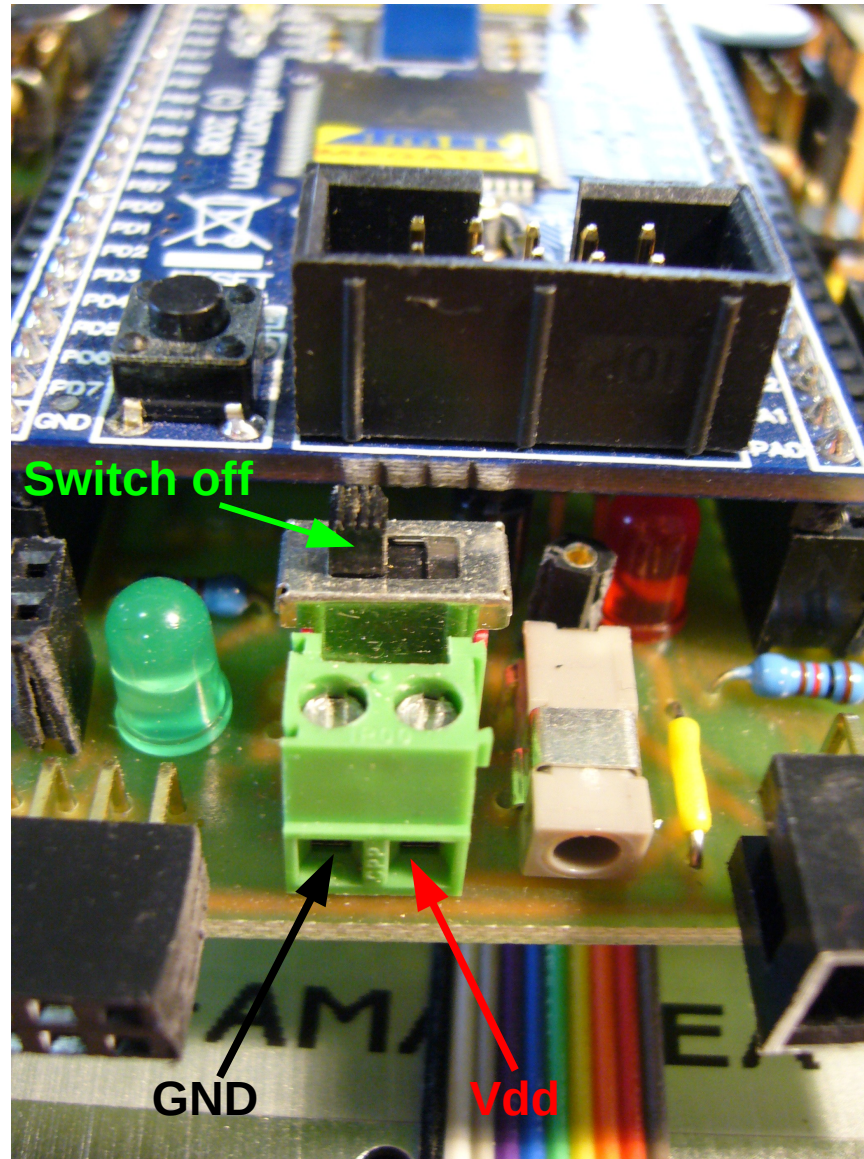

Alimentació

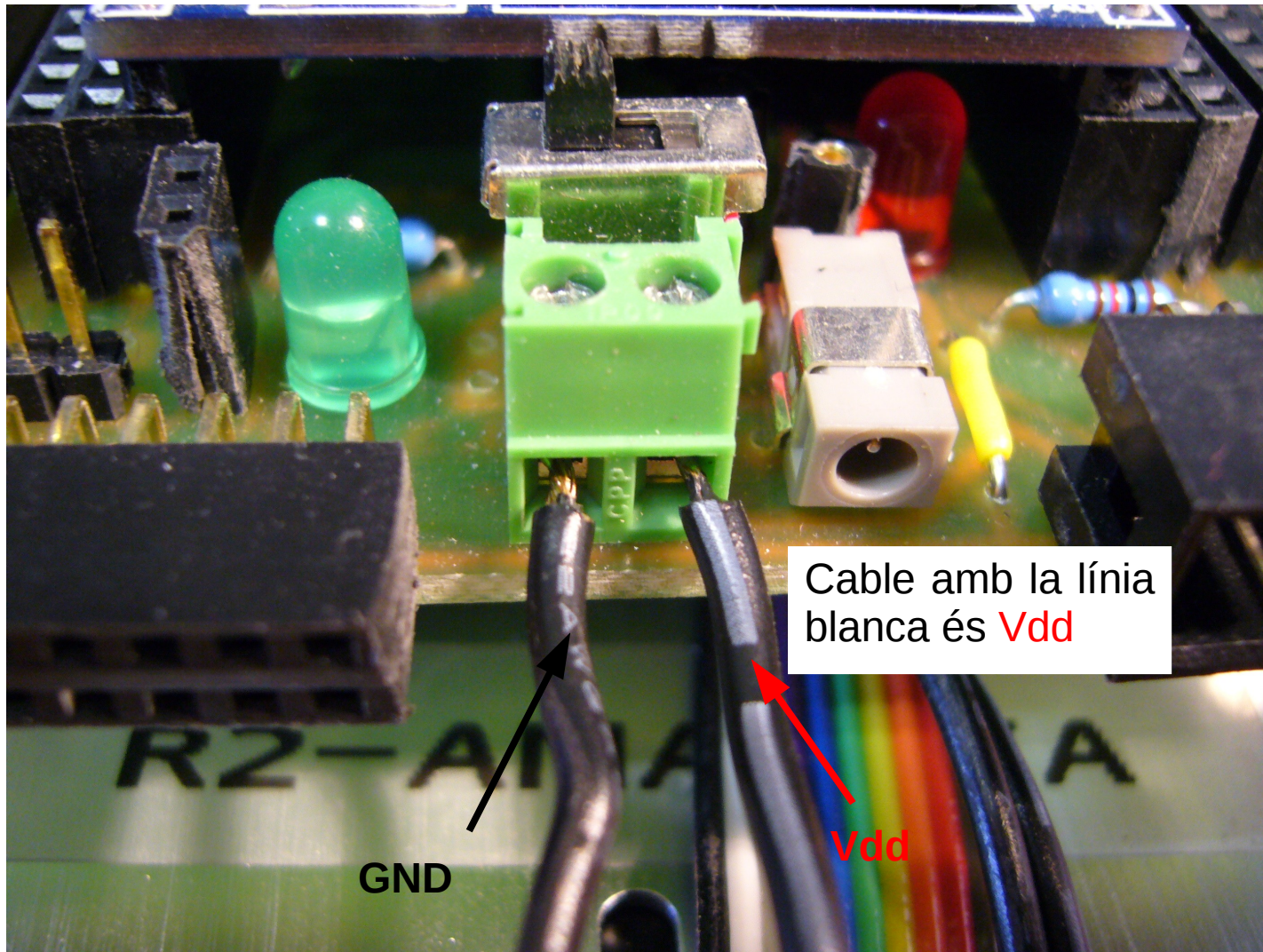

Pinout - USART

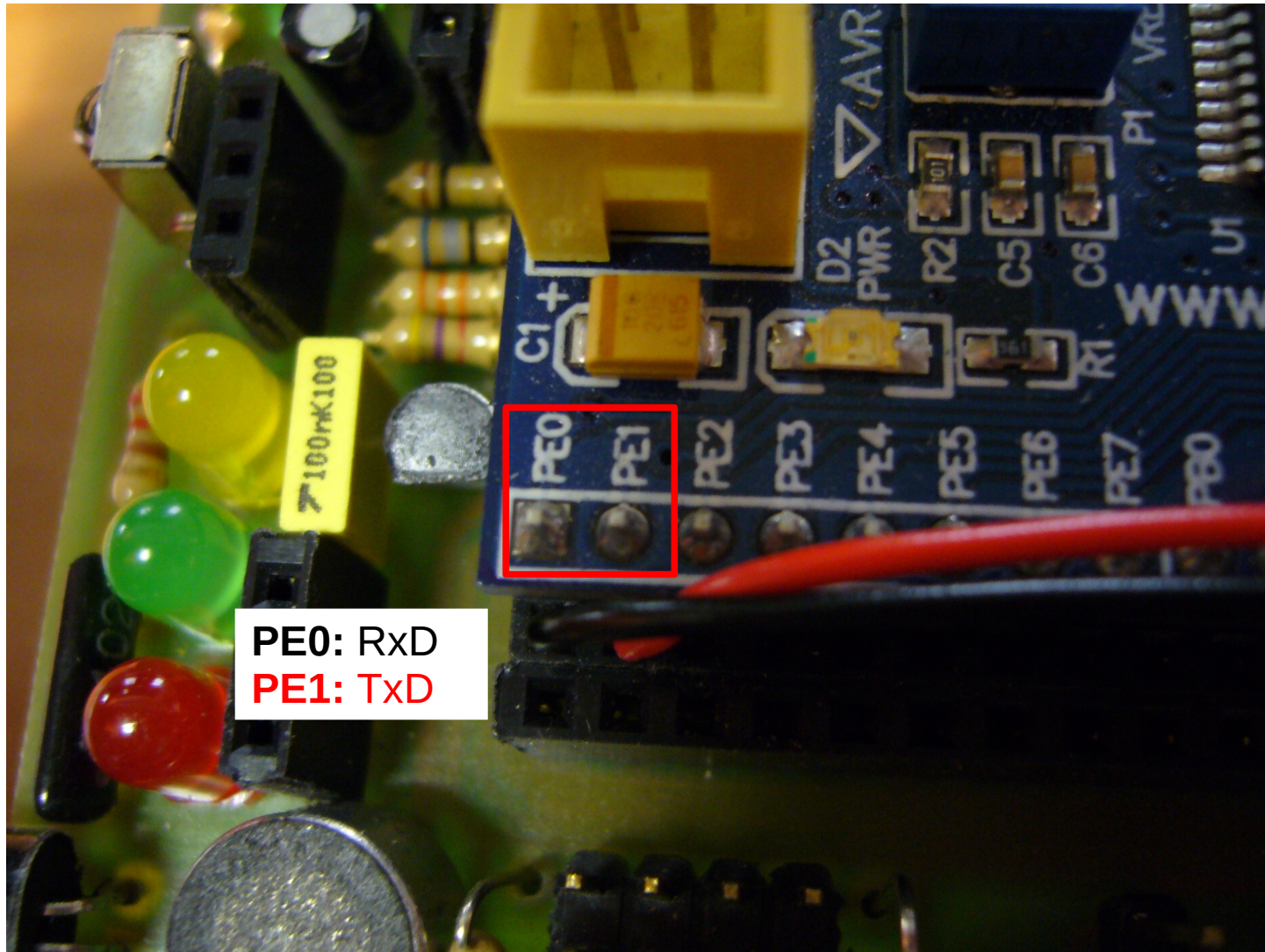

Pinout - Bluetooth

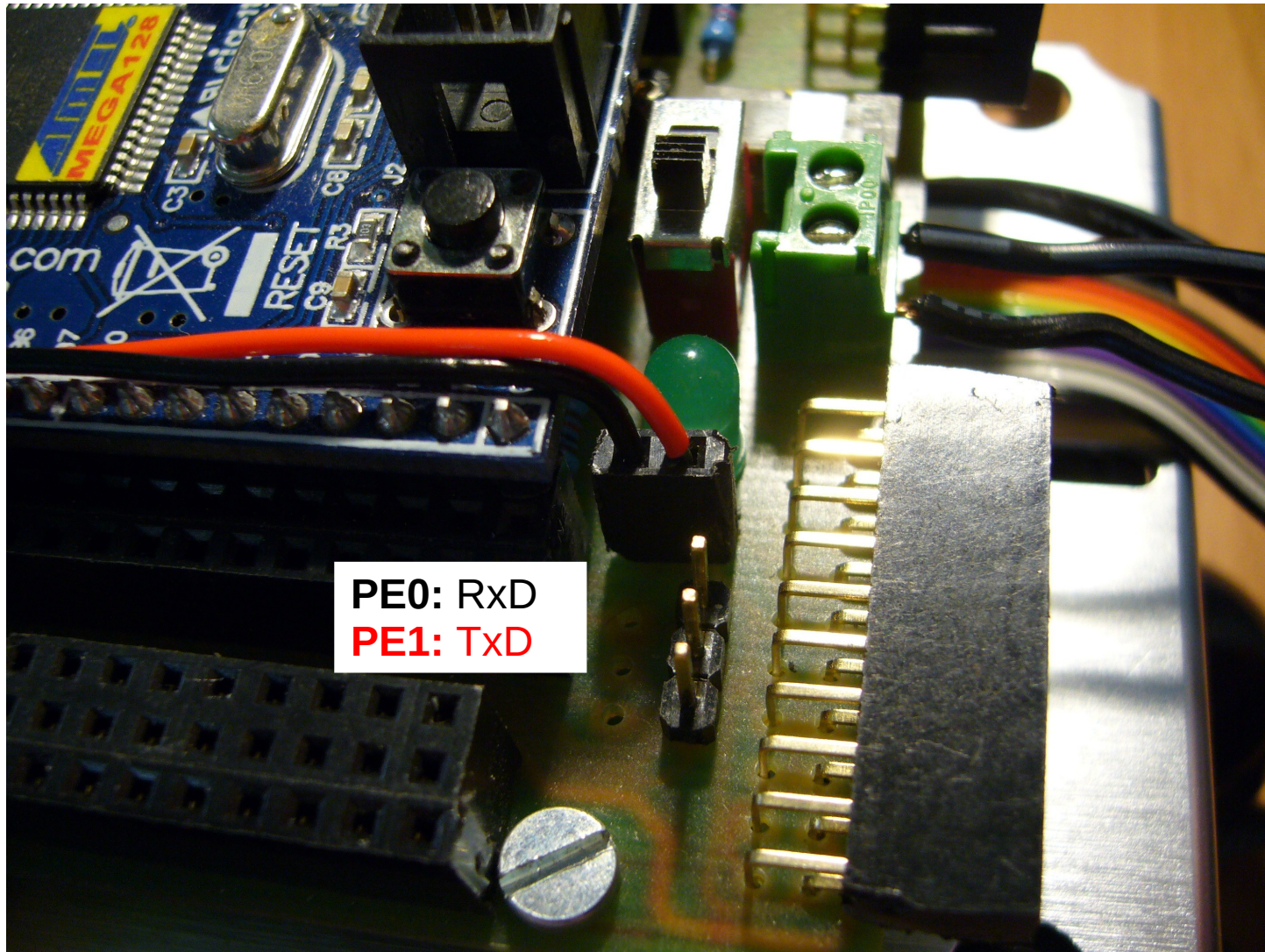

Pinout - Bluetooth

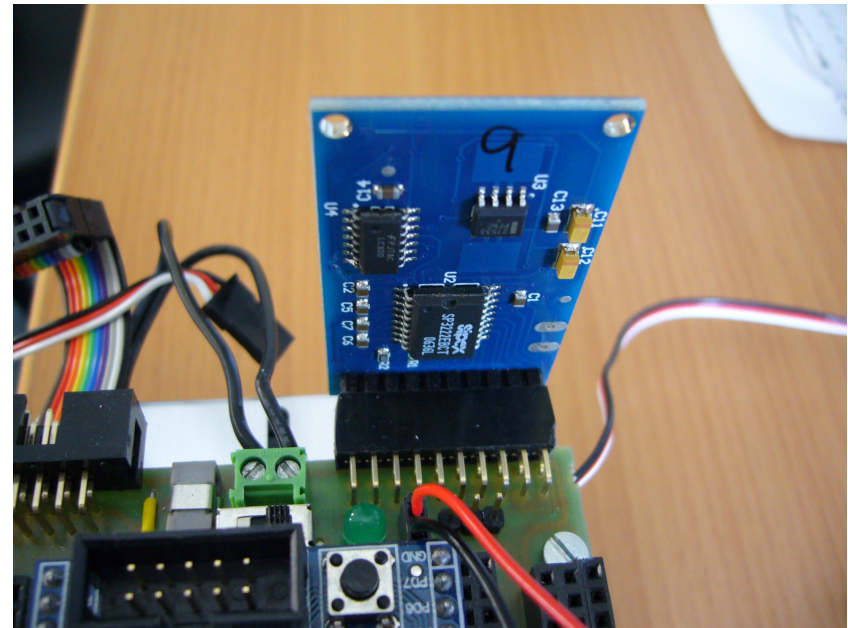
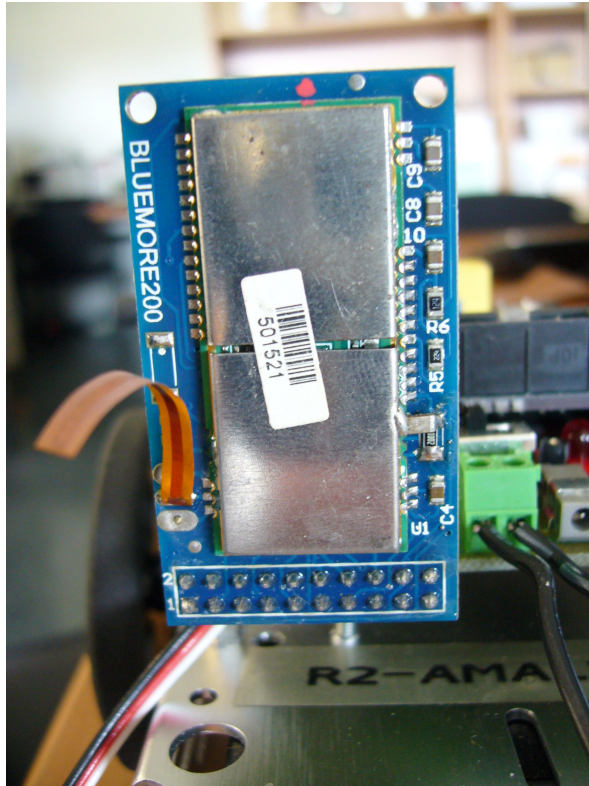

Pinout – Wired Link

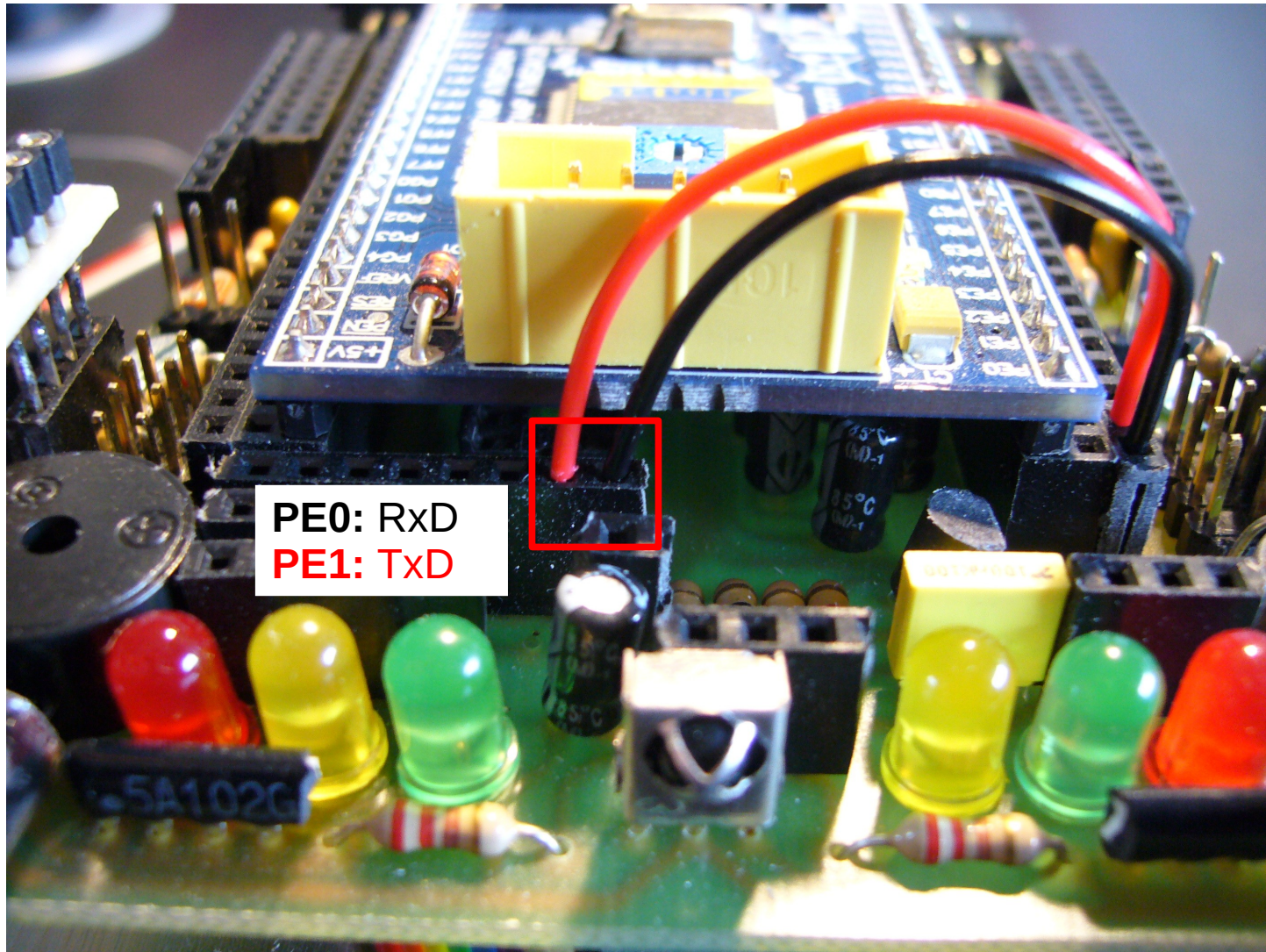

Pinout – Wired Link

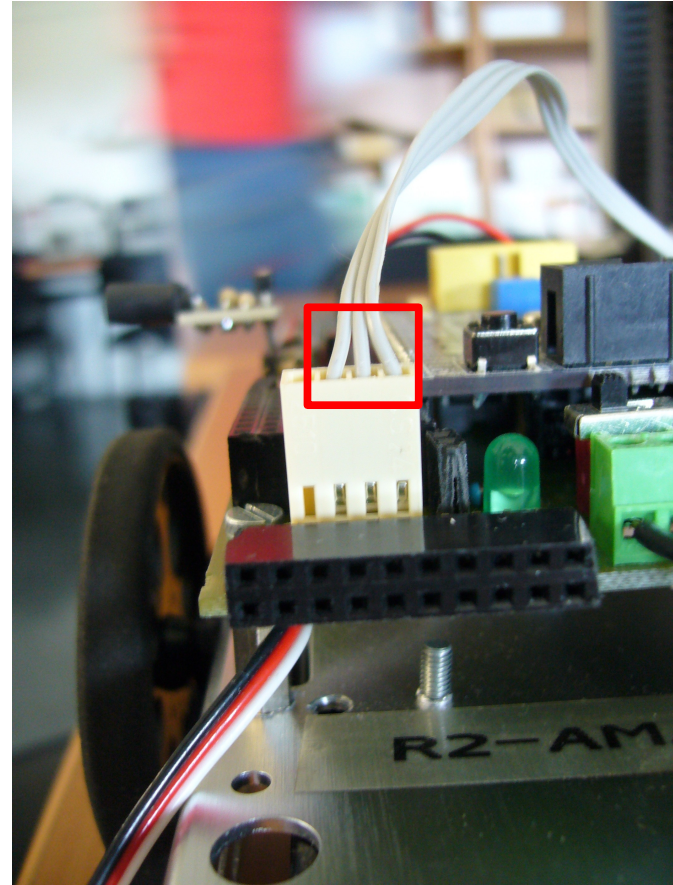
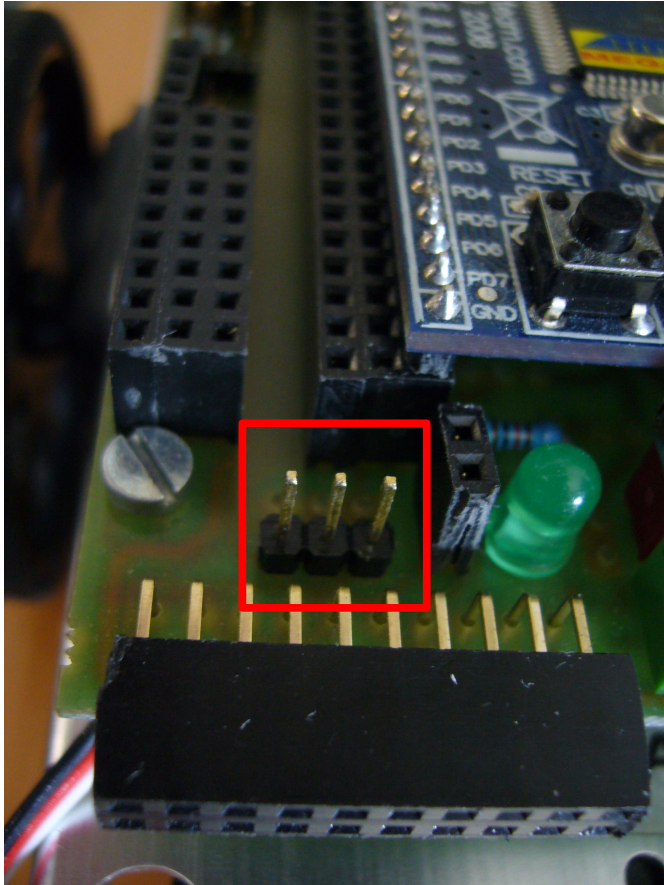

Motors - PWM

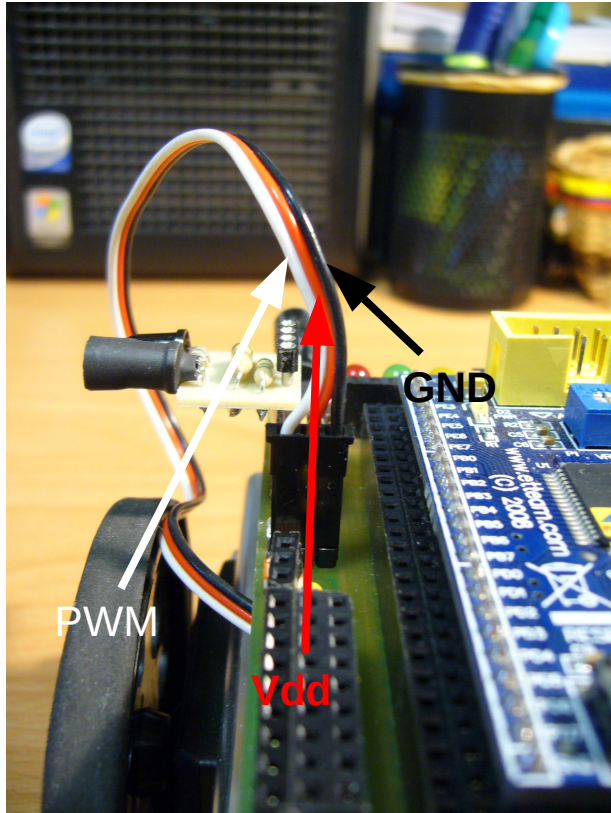

PWM Esquerre

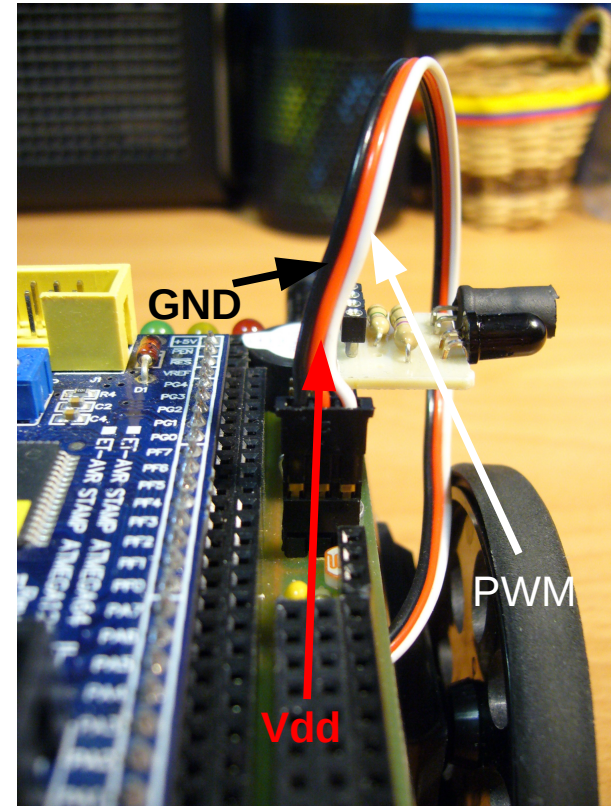

PWM Dret

Motors - PWM

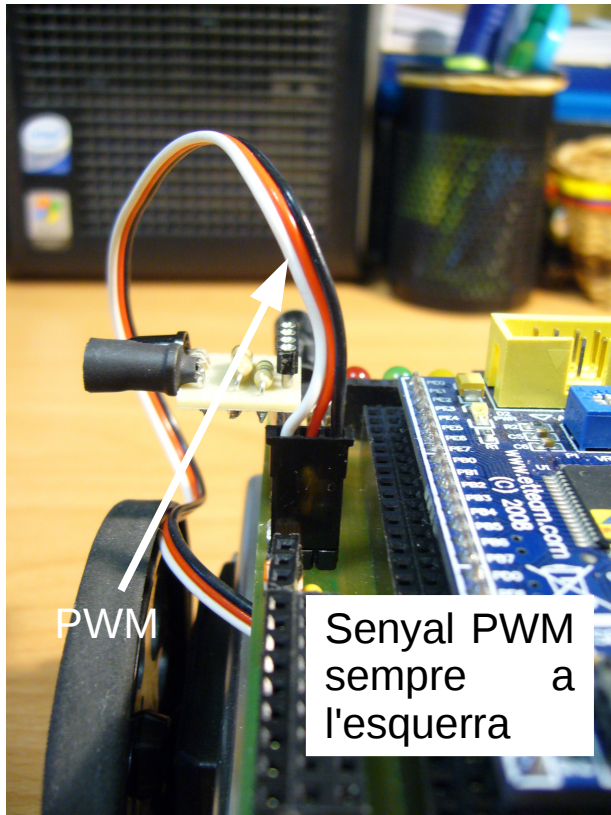

Senyal PWM Esquerre

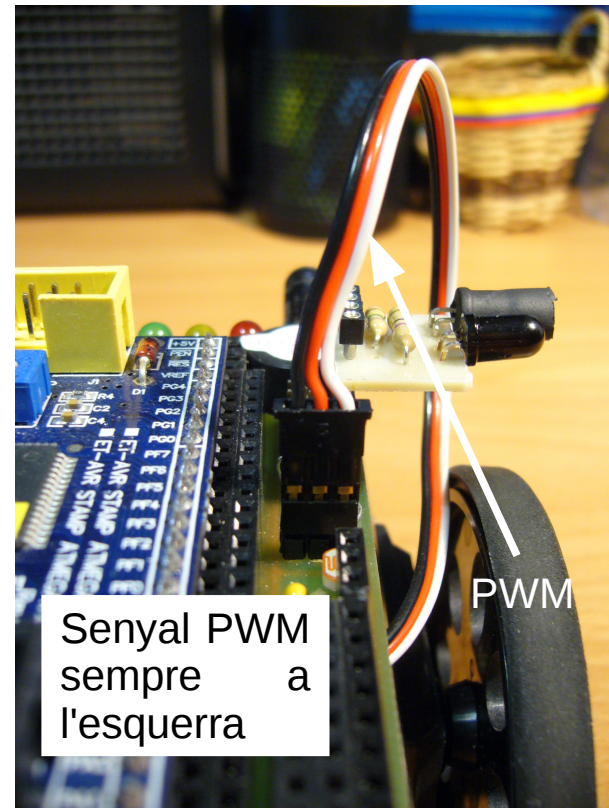

Senyal PWM Dret

Pinout - PWM

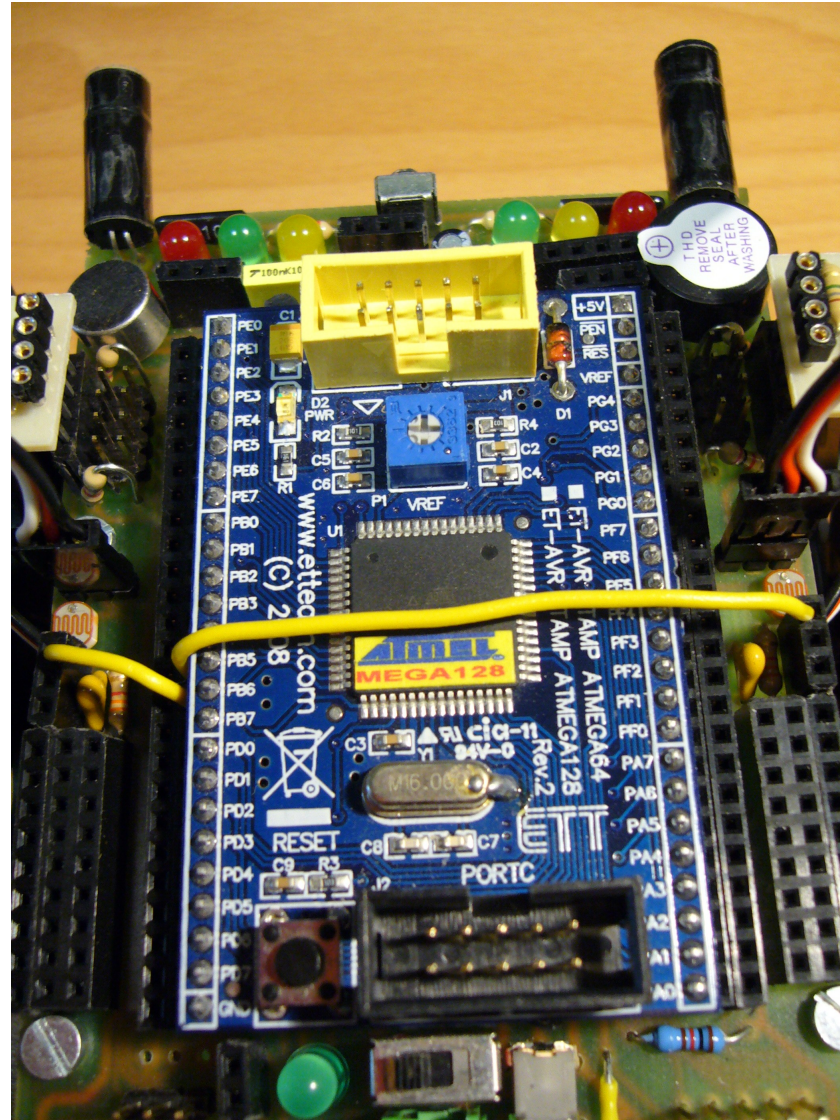

Pinout - PWM

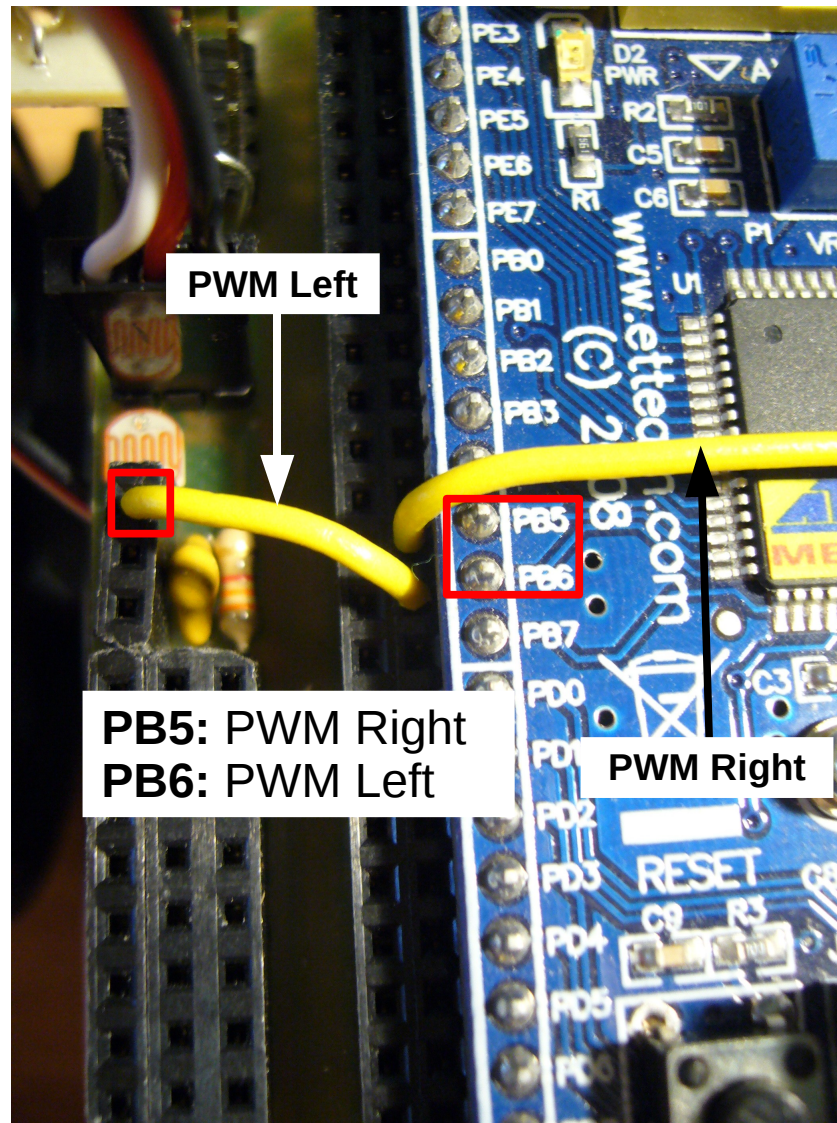

Pinout - PWM

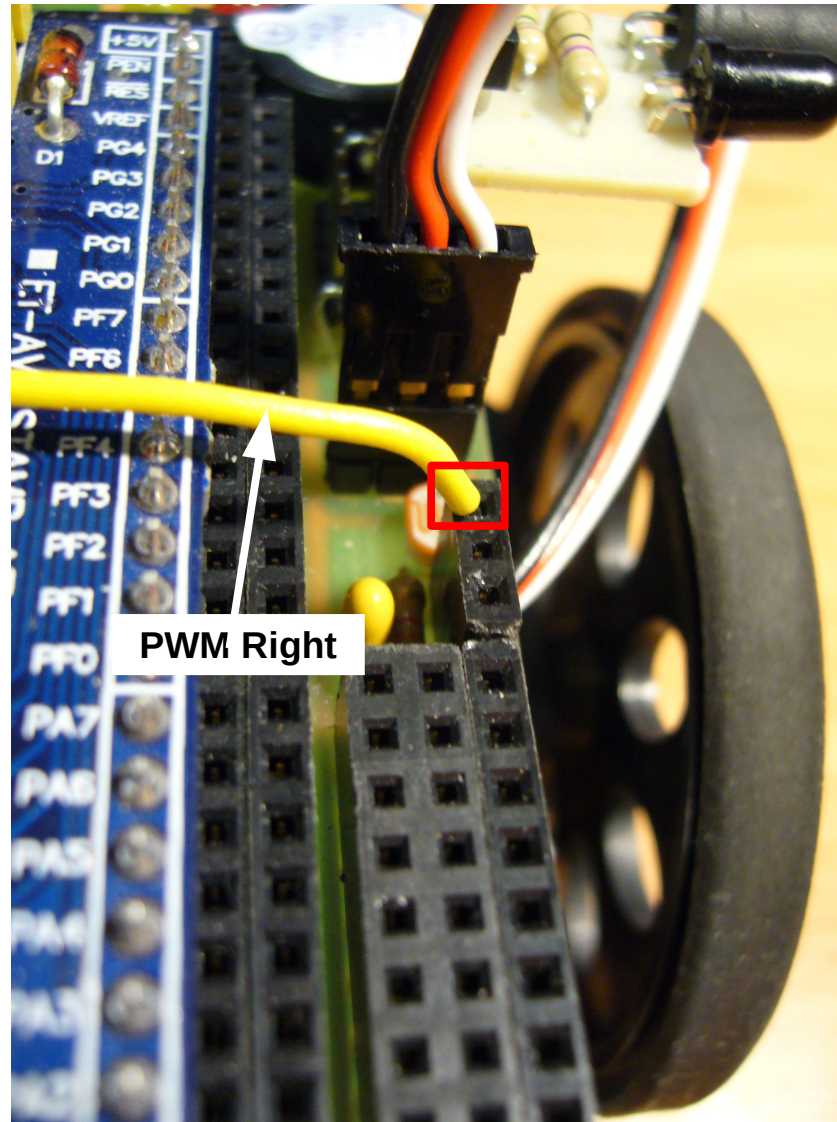

Pinout - IRL

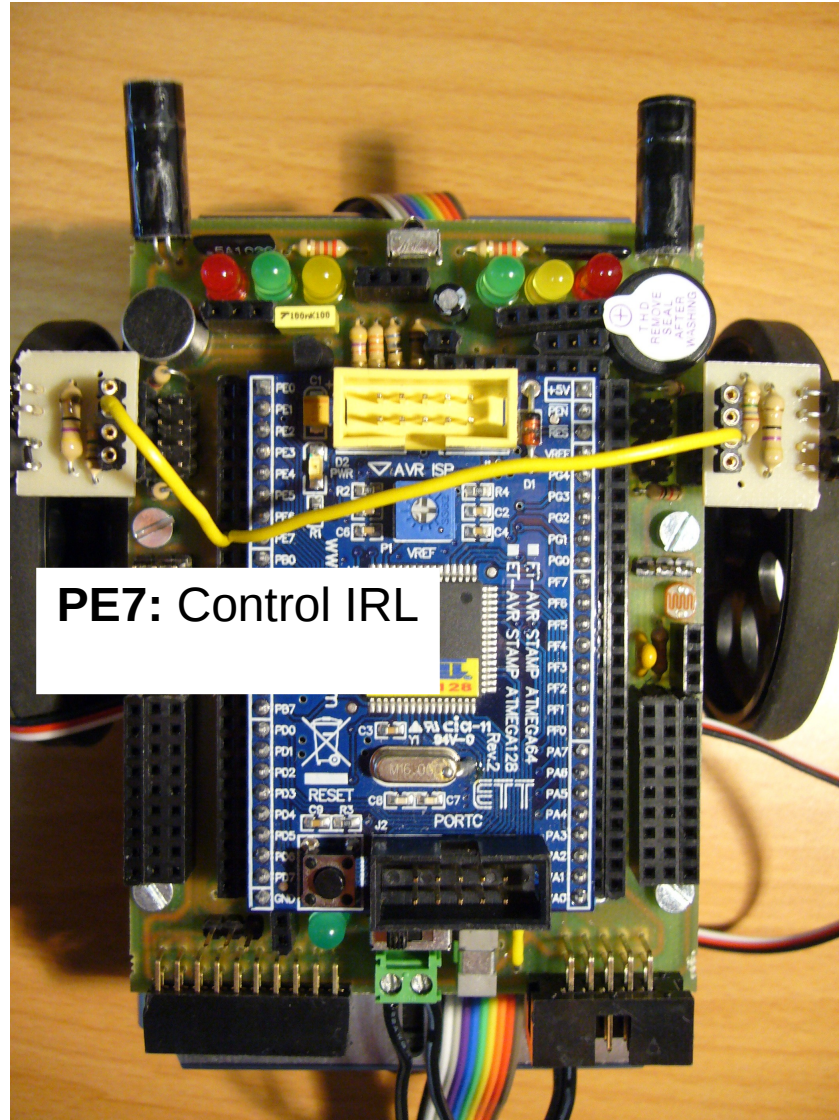

PE7: Control IRL

Pinout - IRL

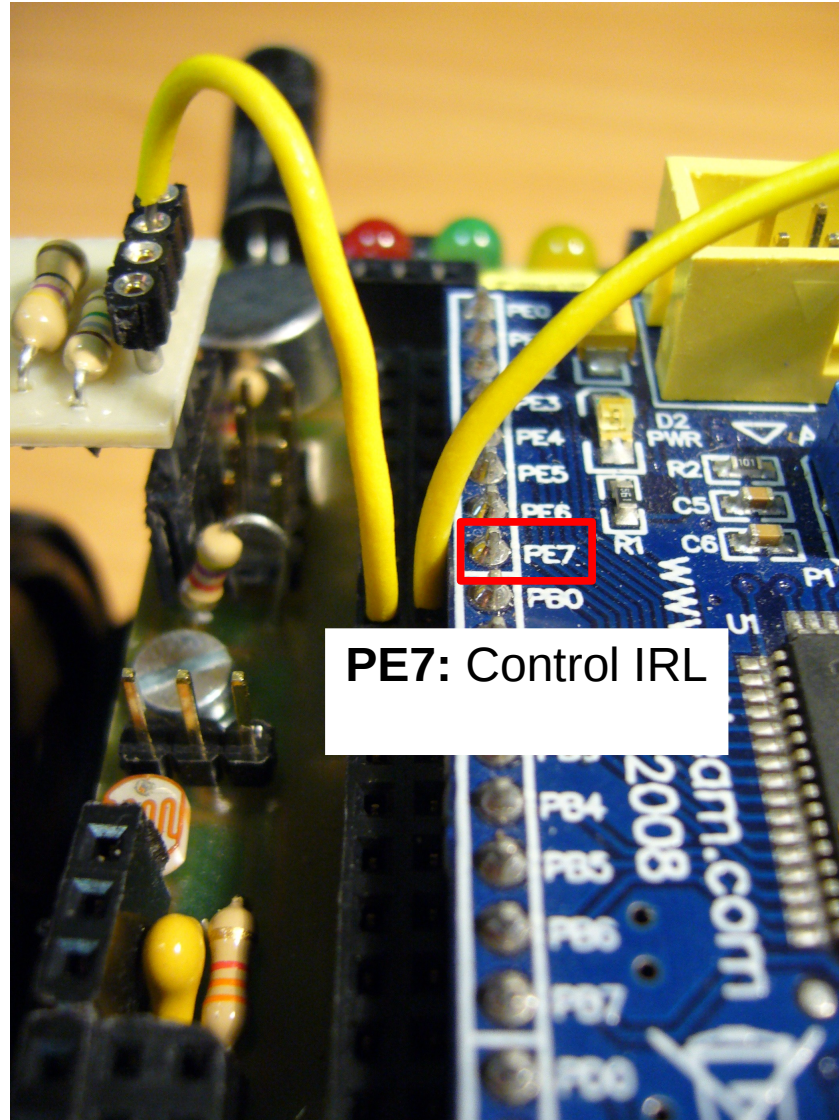

PE7: Control IRL

Pinout - IRL

IRL Left

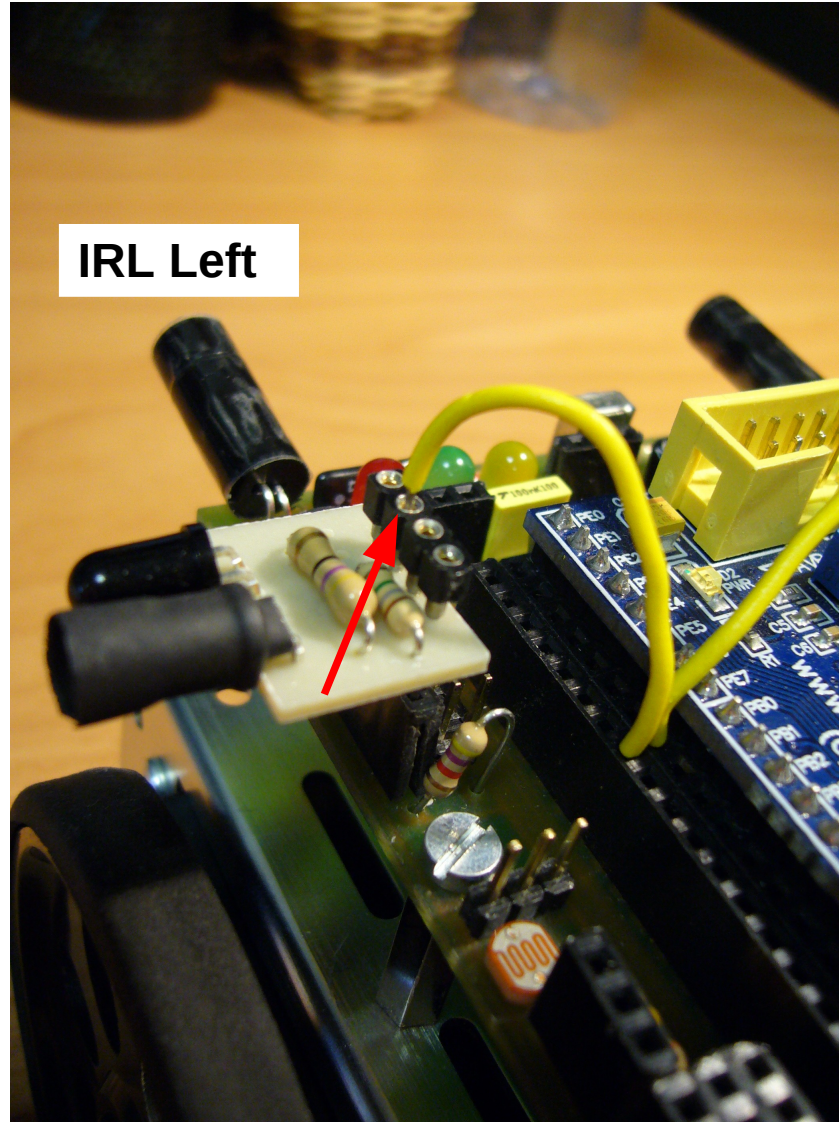

Pinout - IRL

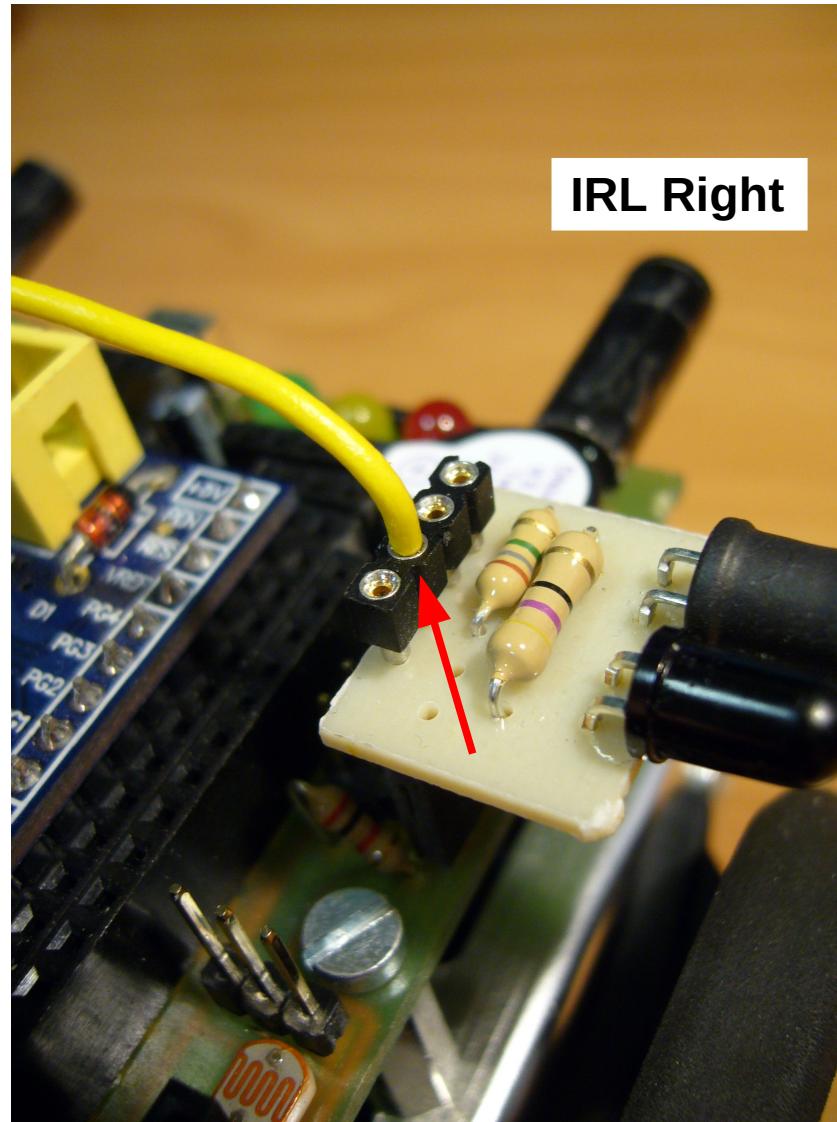

Pinout - IRL

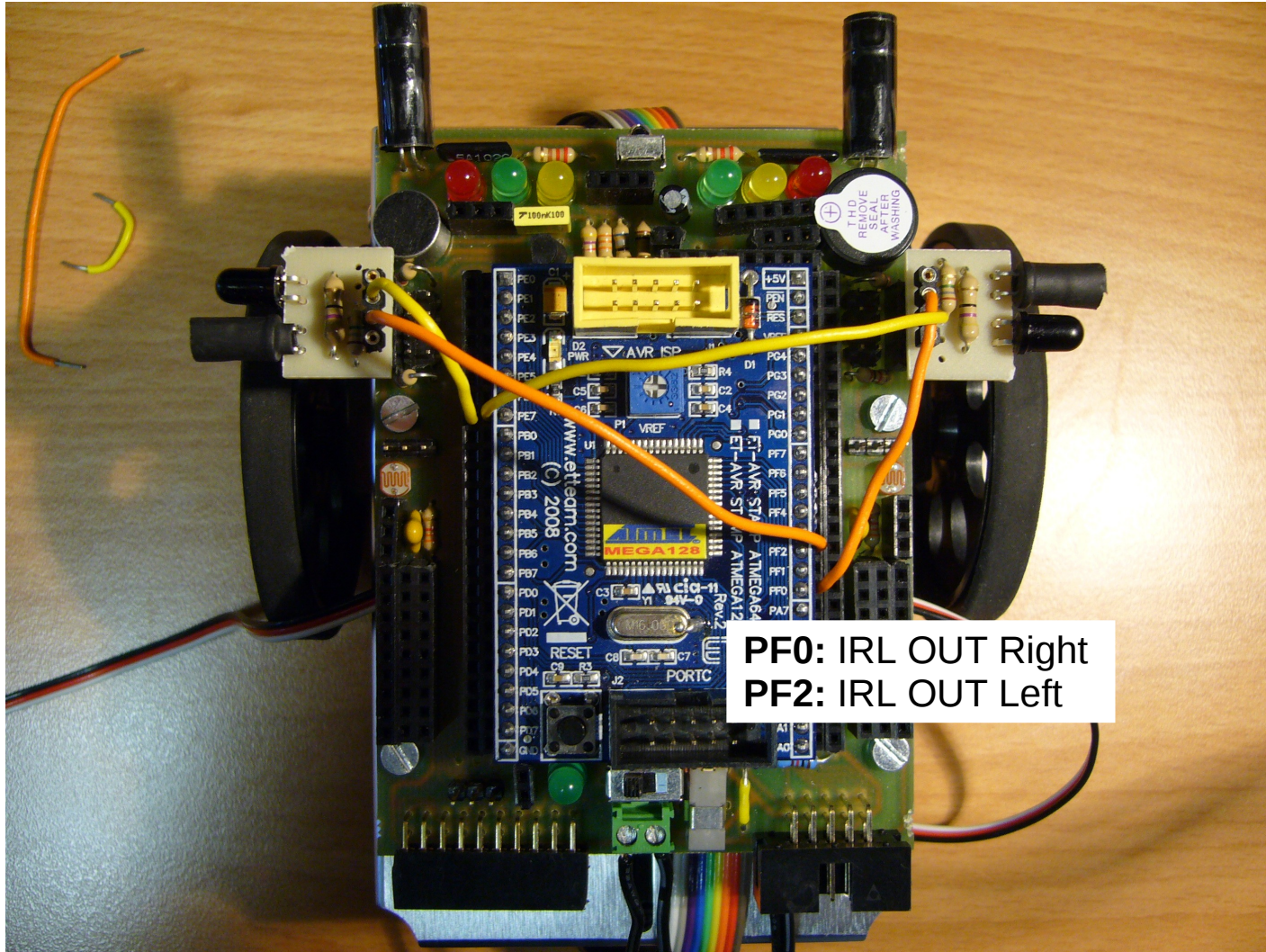

Pinout - IRL

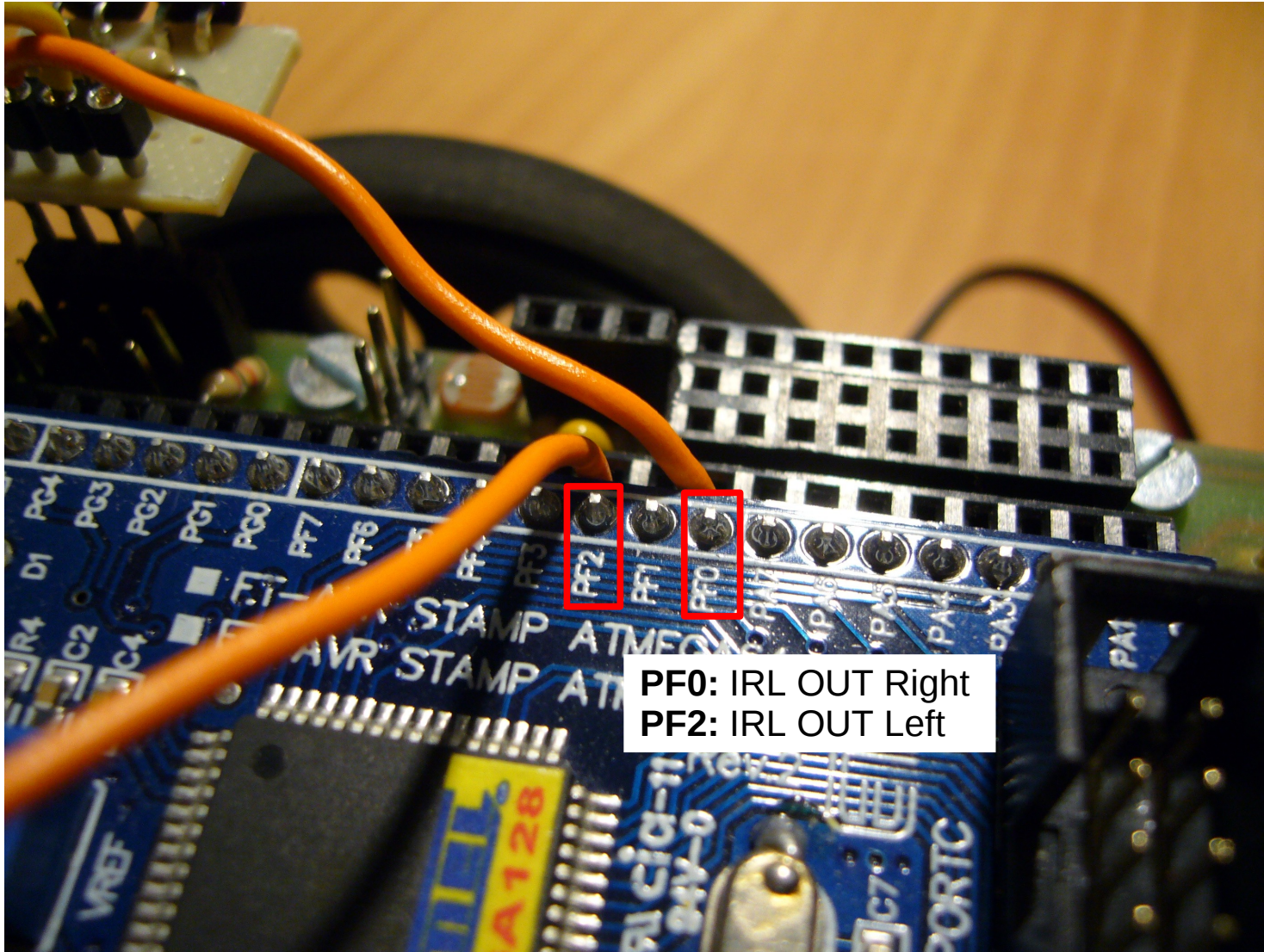

PF0: IRL OUT Right
PF2: IRL OUT Left

Pinout – IRL Left

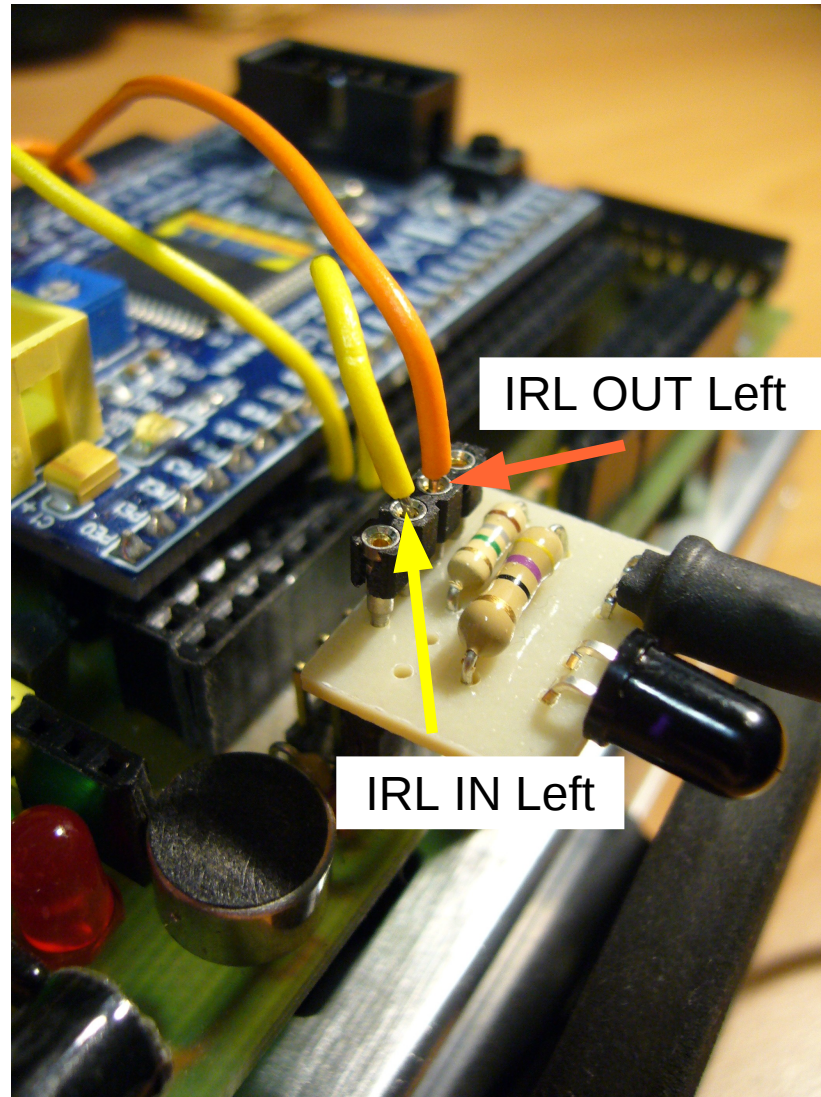

Pinout – IRL Right

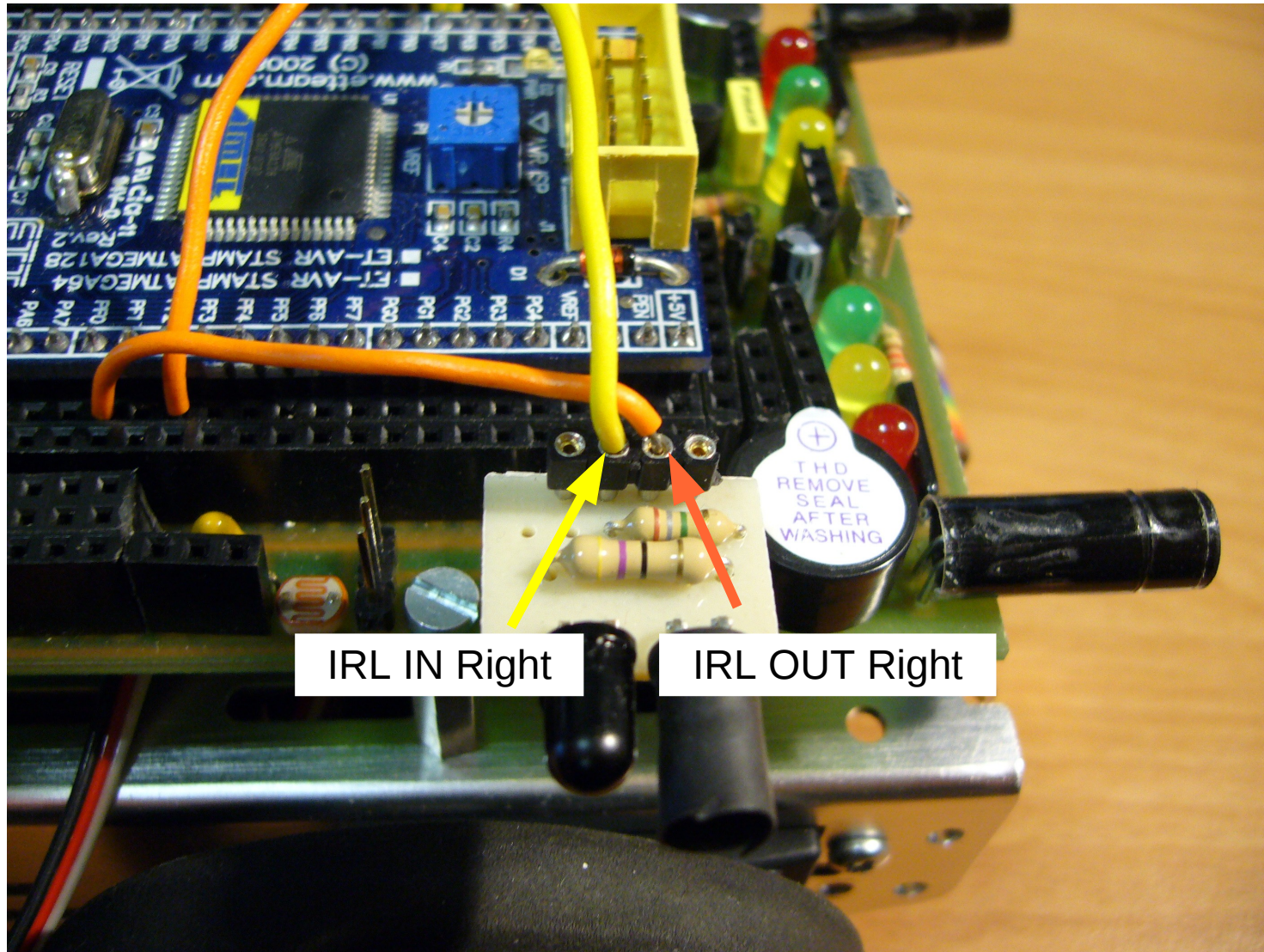

IRL IN Right

IRL OUT Right

Pinout – IRF

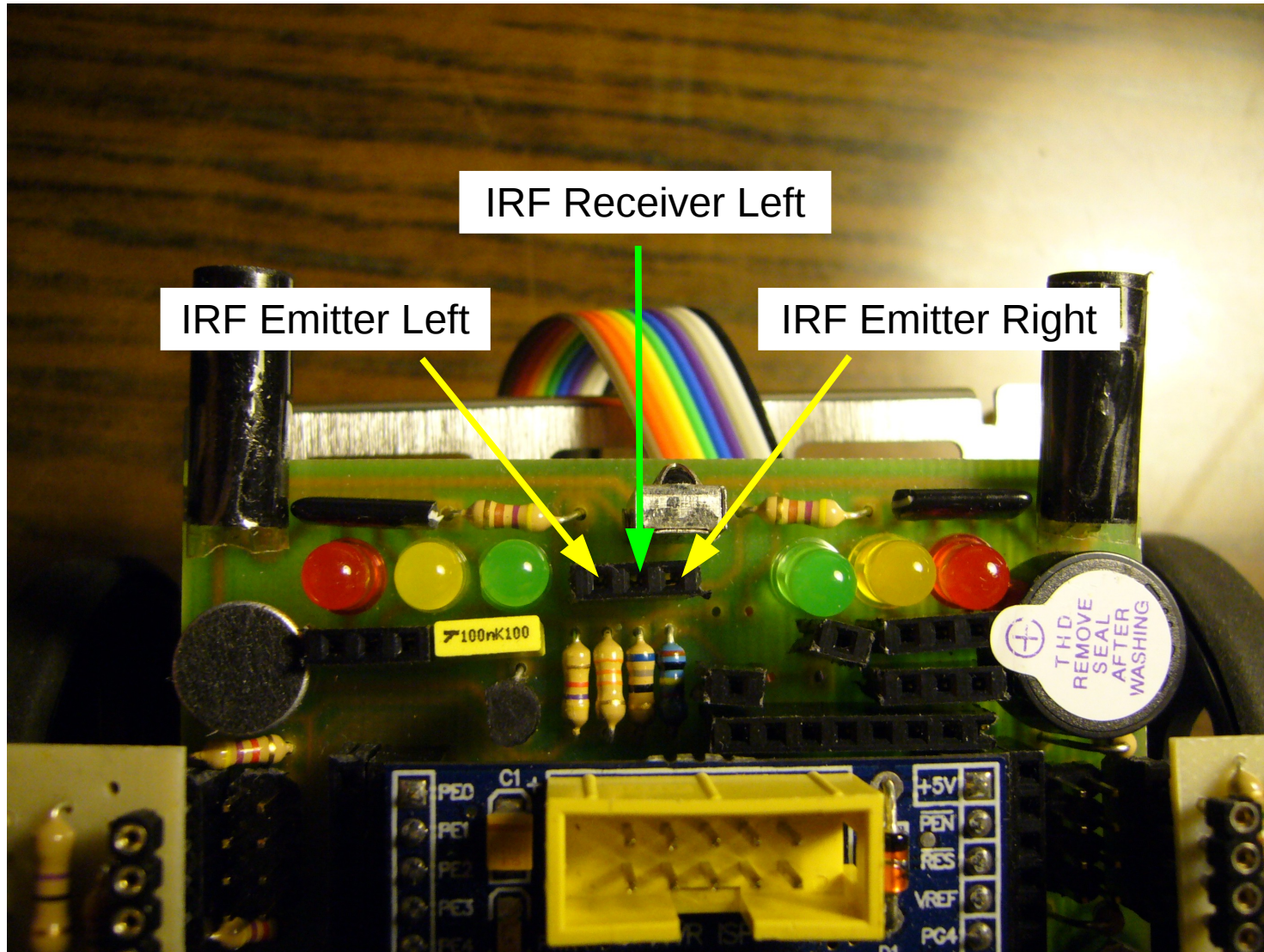

Pinout – IRF

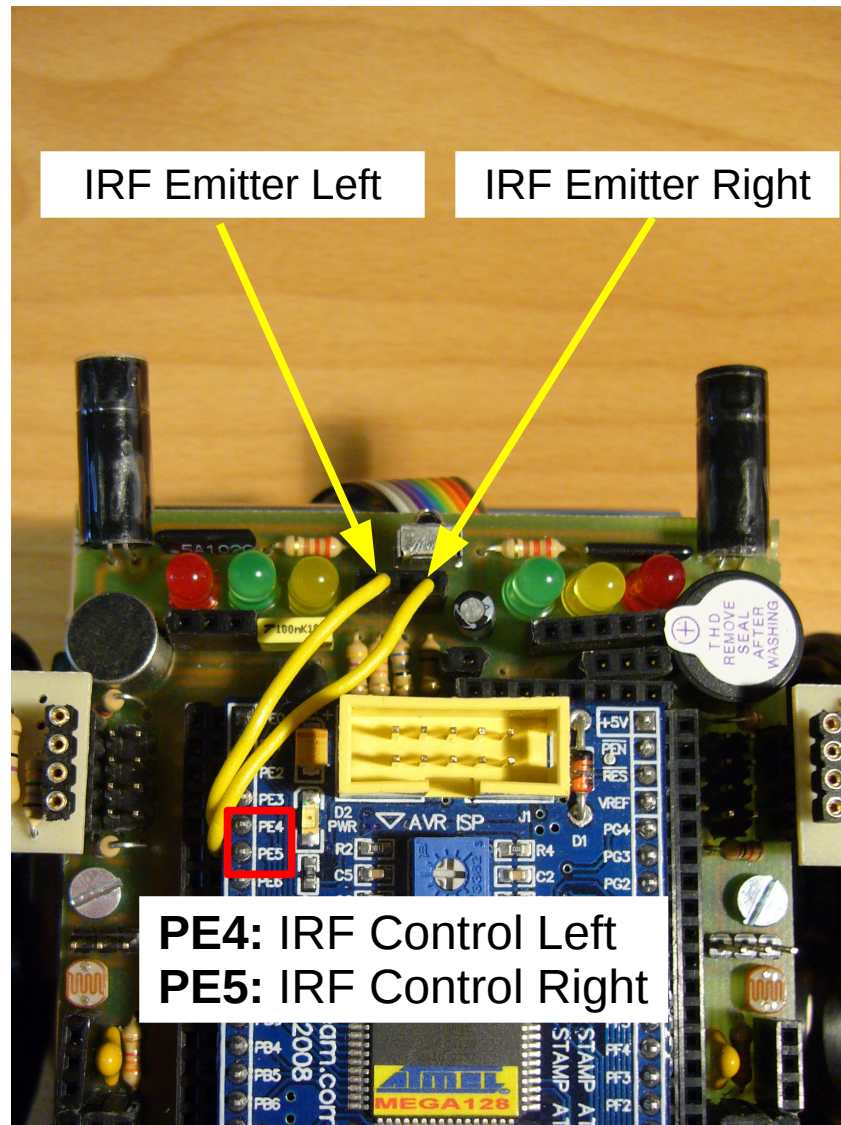

Pinout – IRF

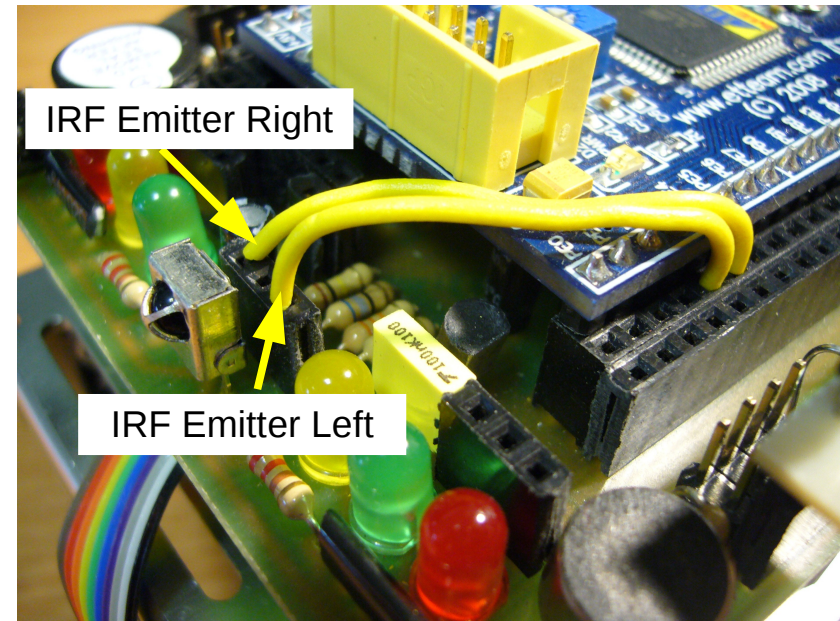
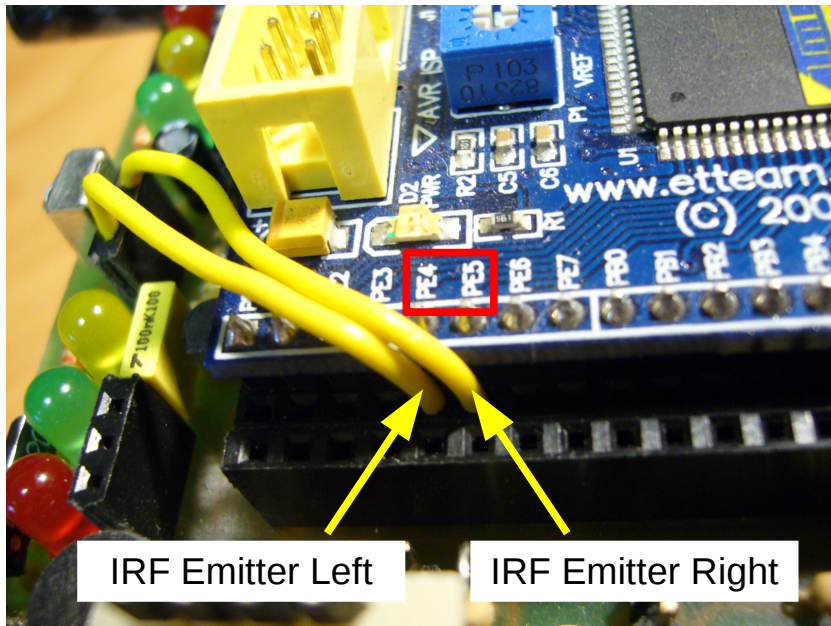

Pinout – IRF

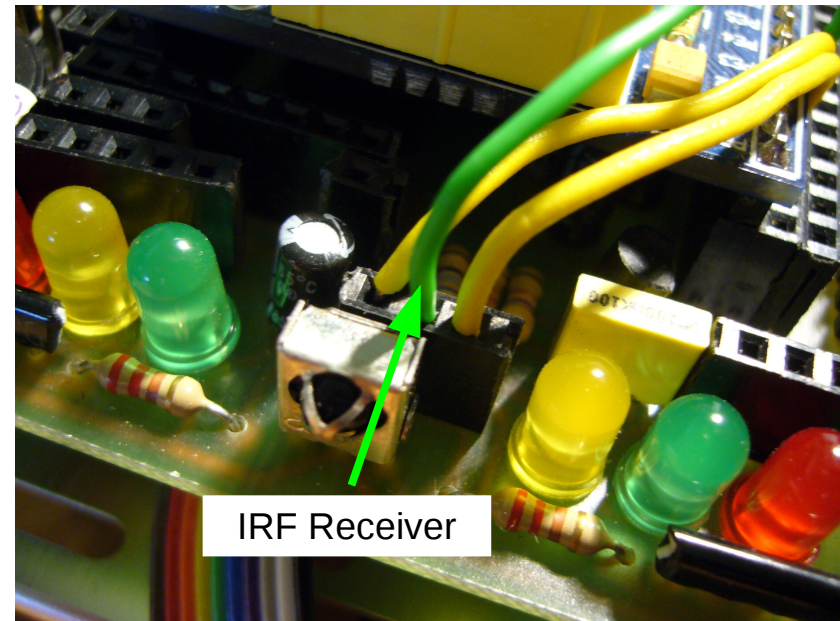
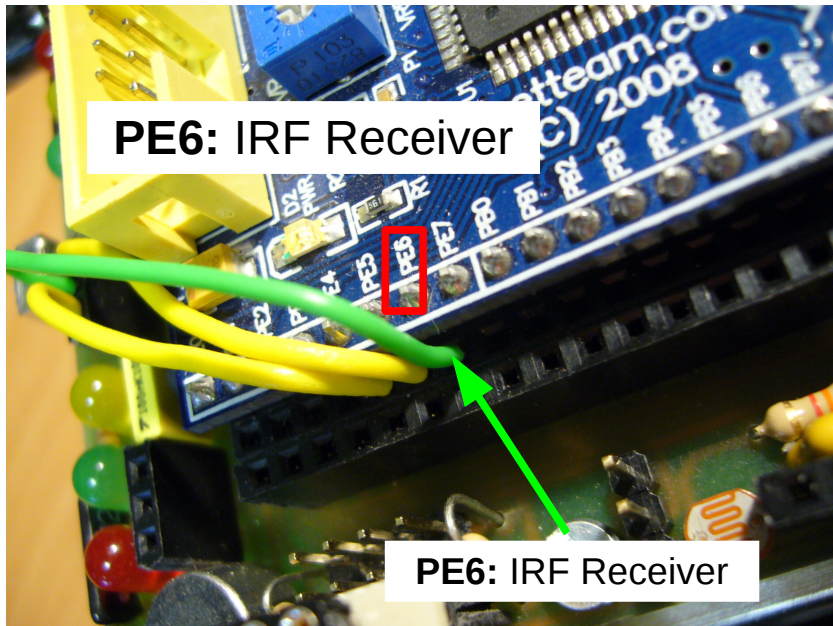

Pinout – LDR

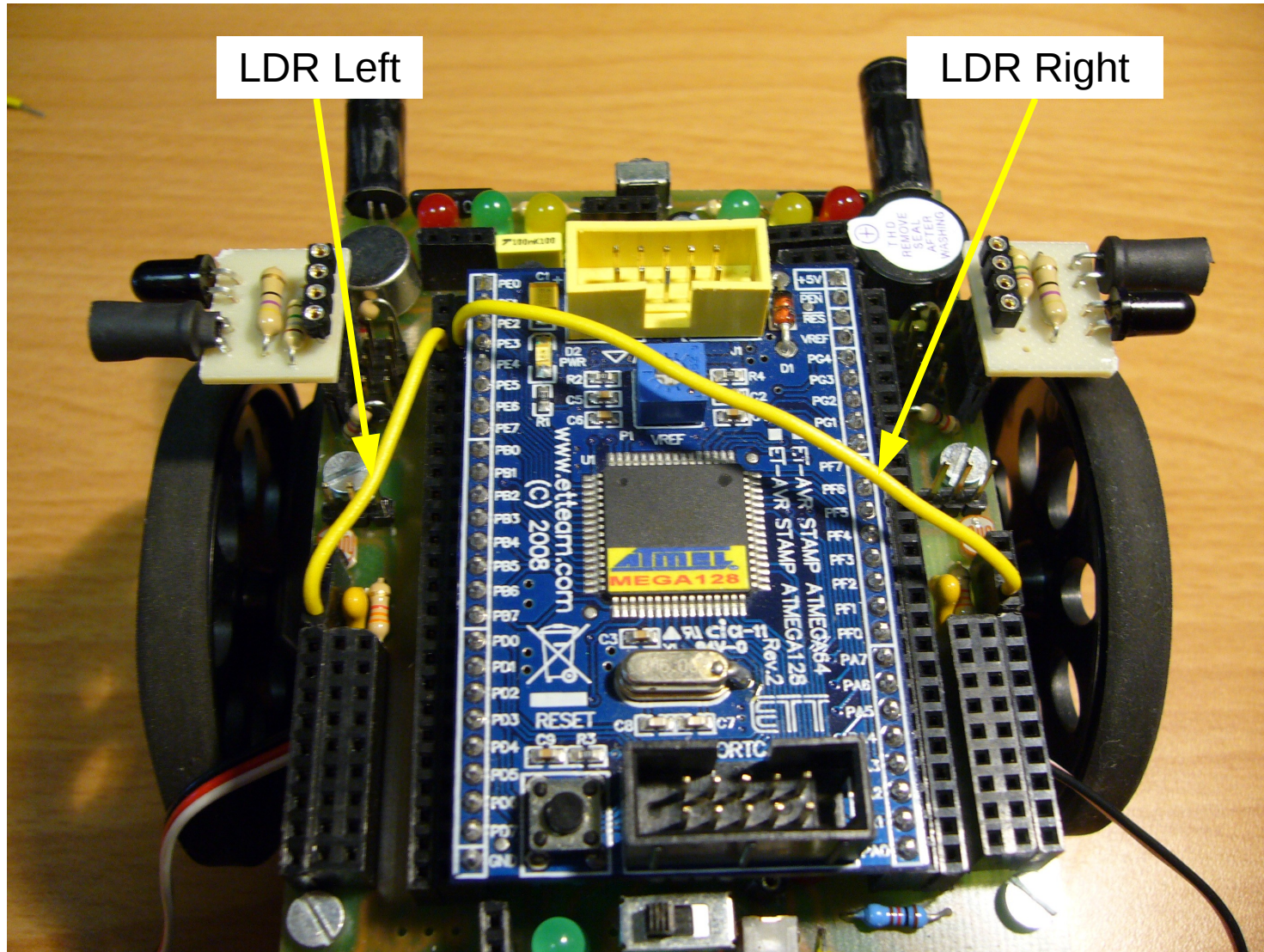

Pinout – LDR

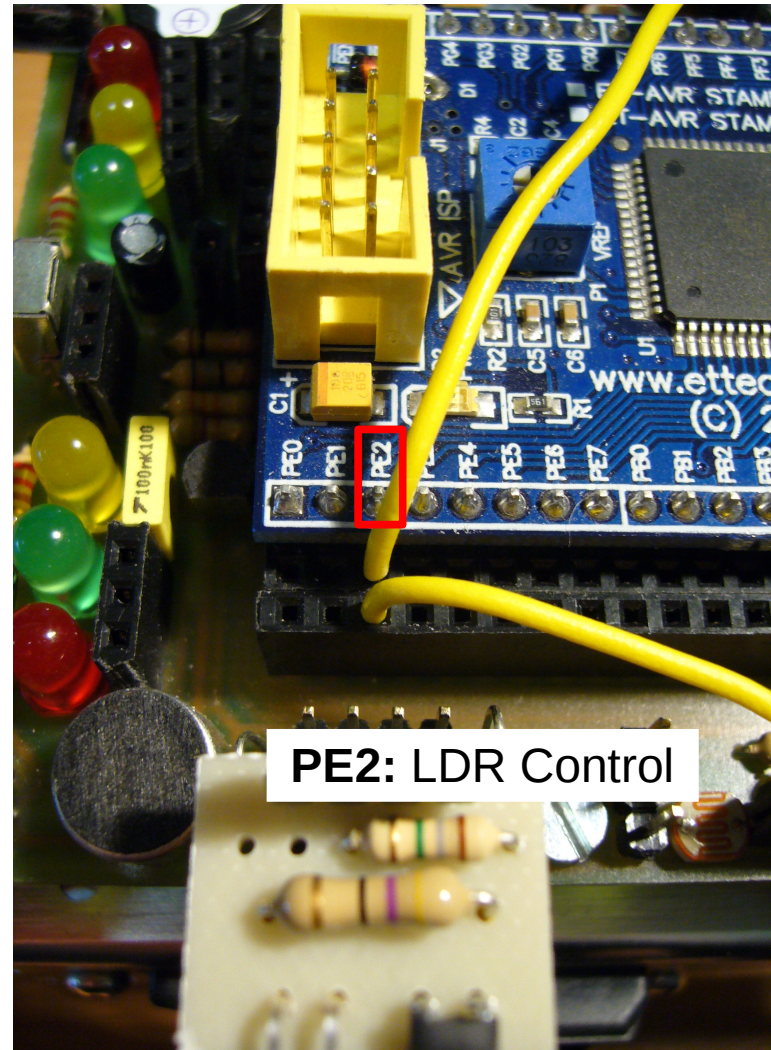

PE2: LDR Control

Pinout – LDR

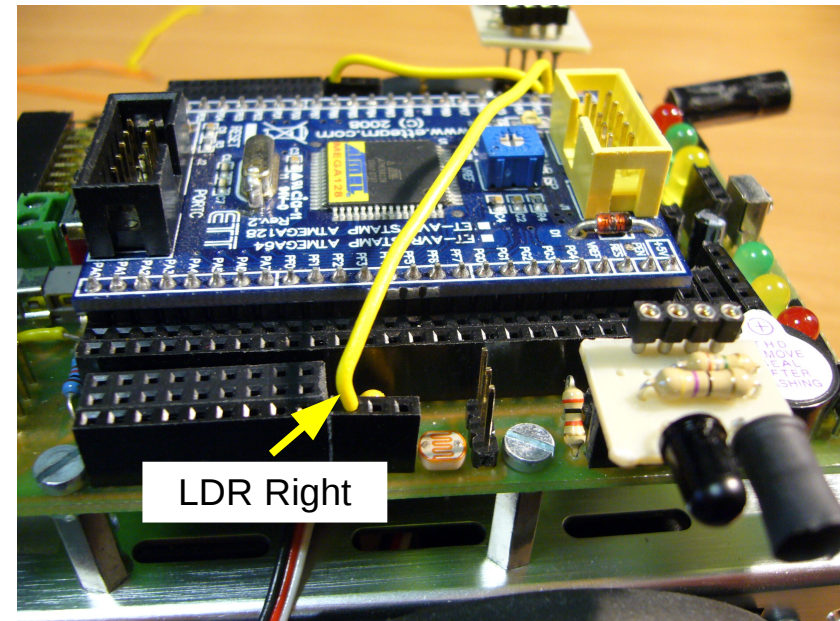
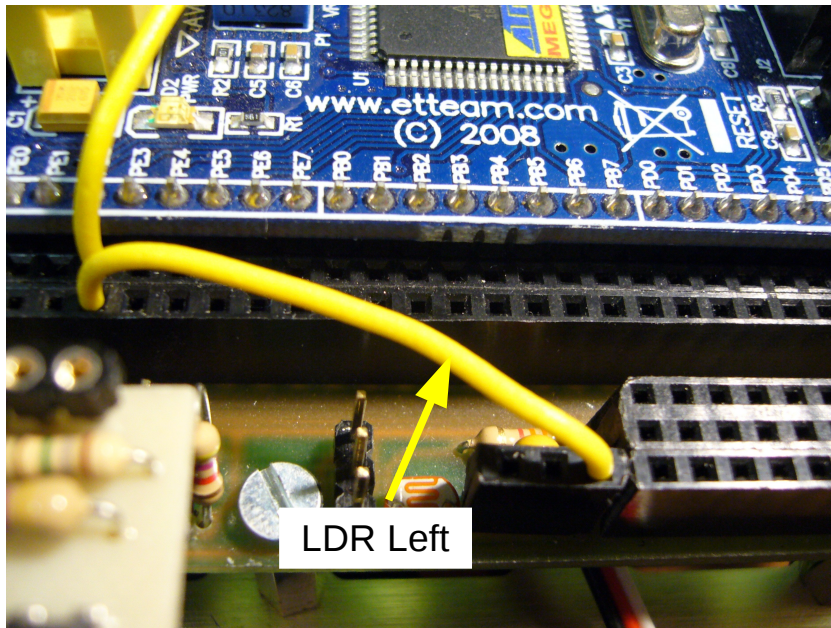

Pinout – LDR

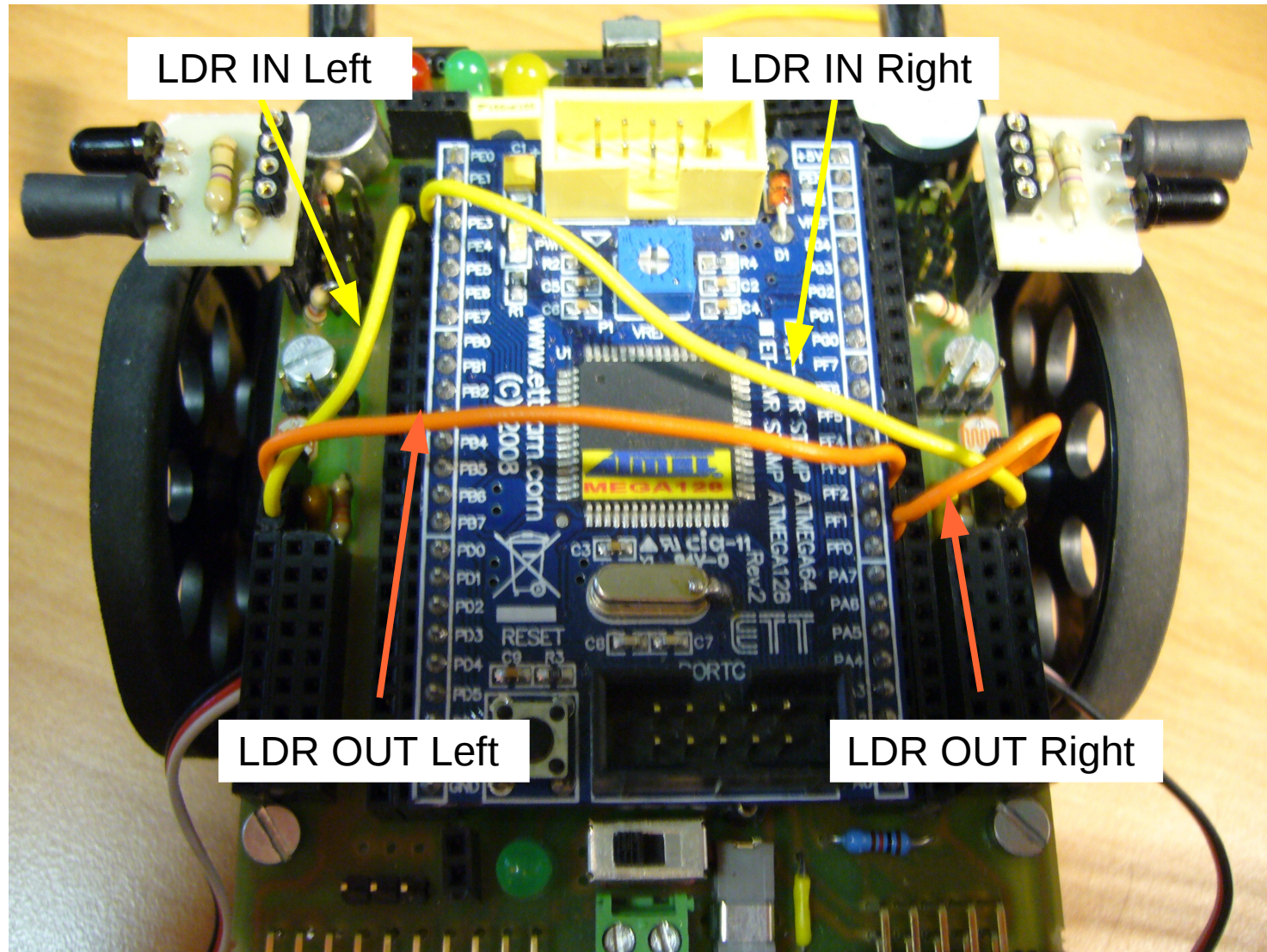

Pinout – LDR

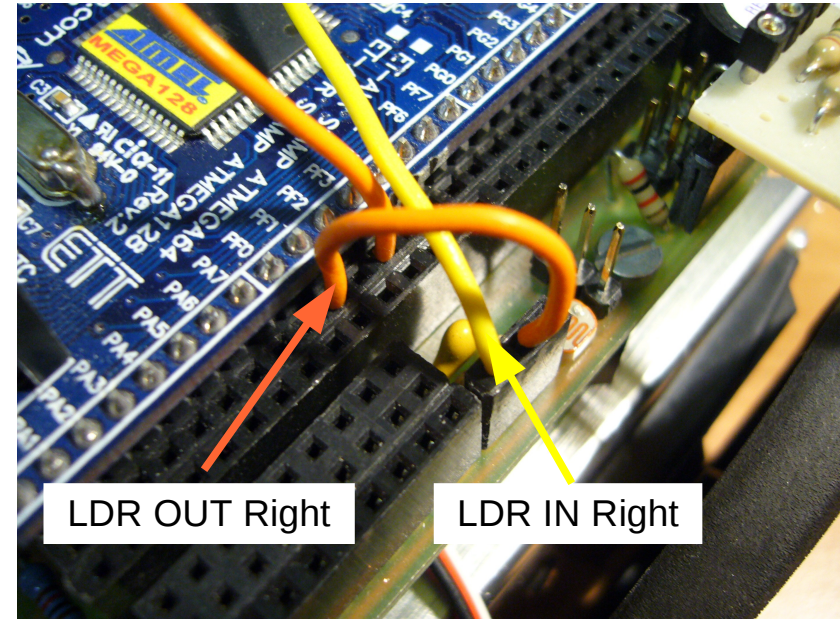
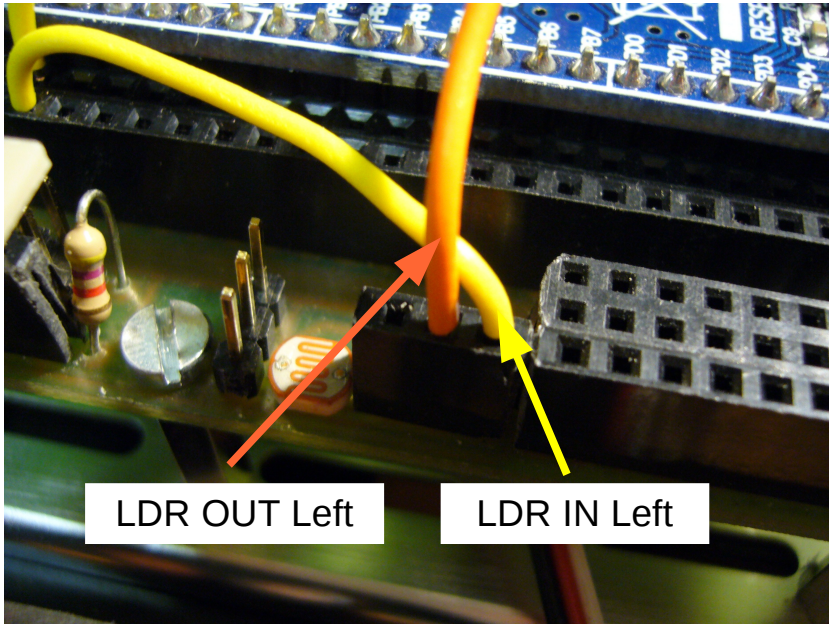

Pinout – LED

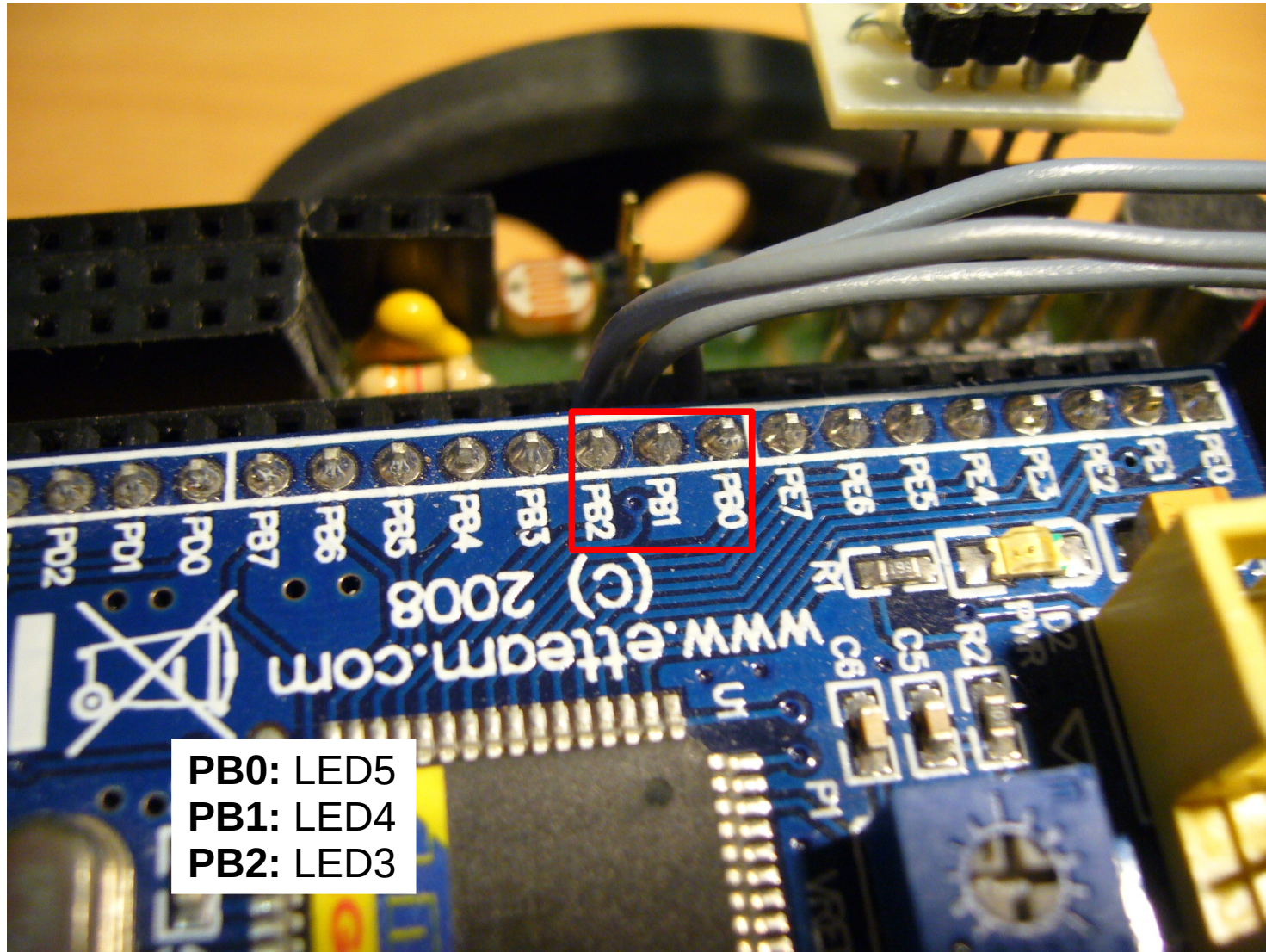

Pinout – LED

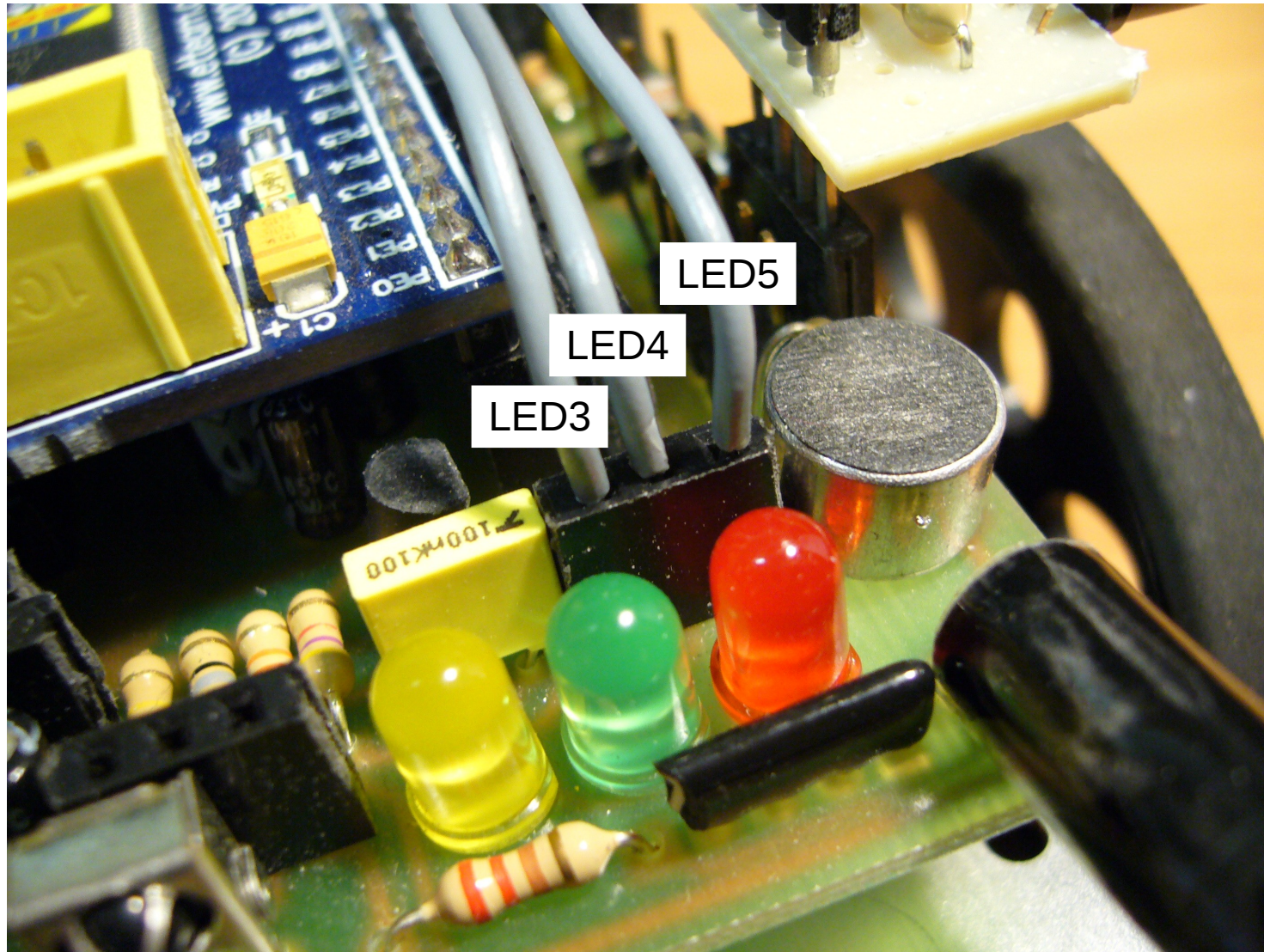

Pinout – LED

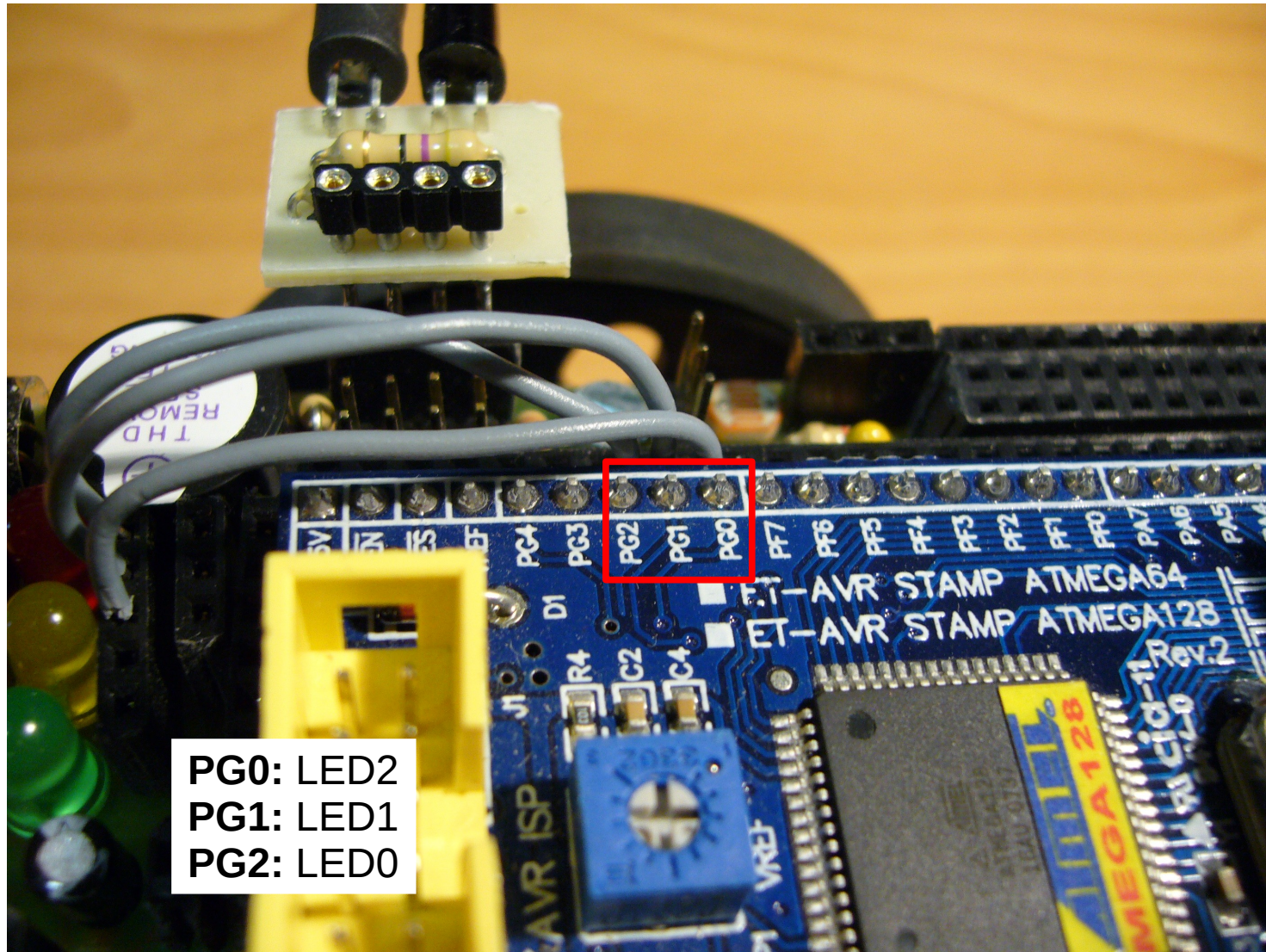

Pinout – LED

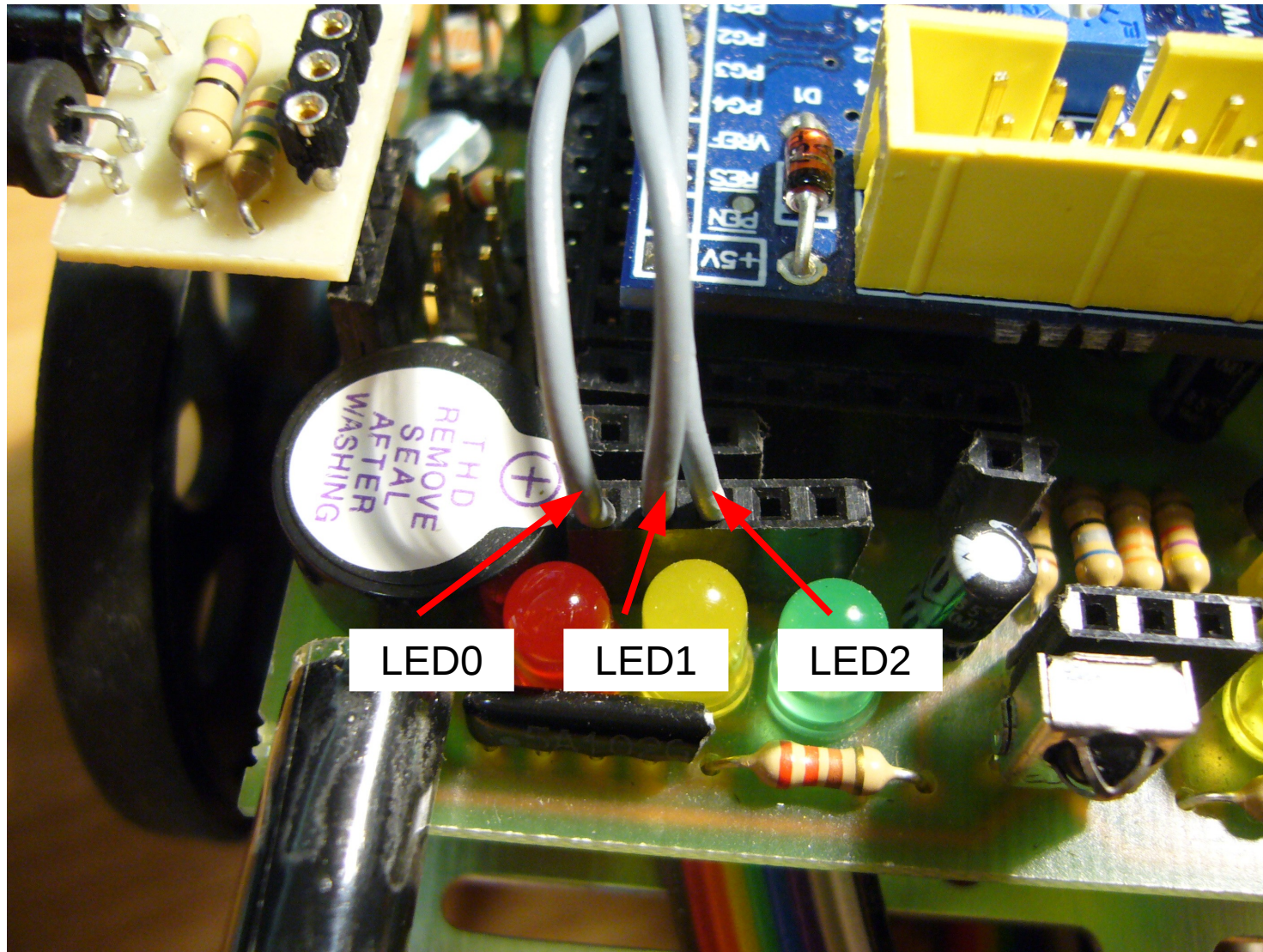

Pinout – Piezzo buzzer

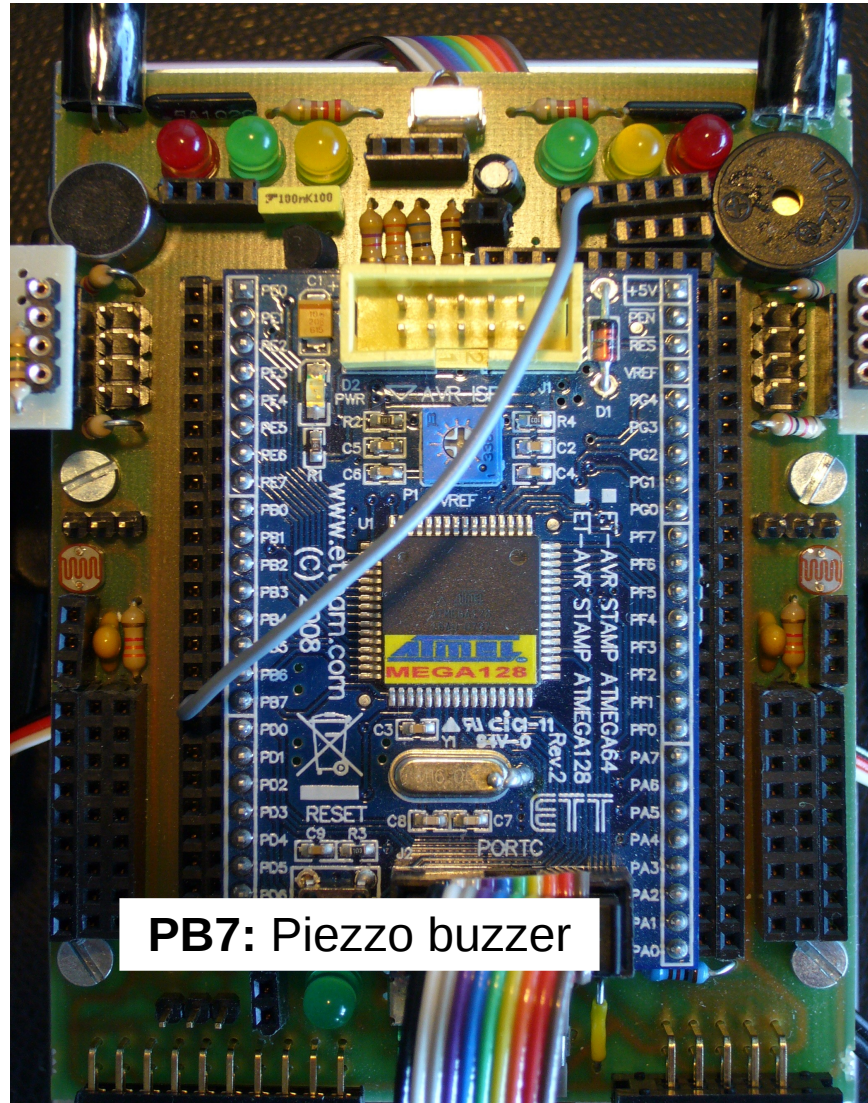

PB7: Piezzo buzzer

Pinout – Piezzo buzzer

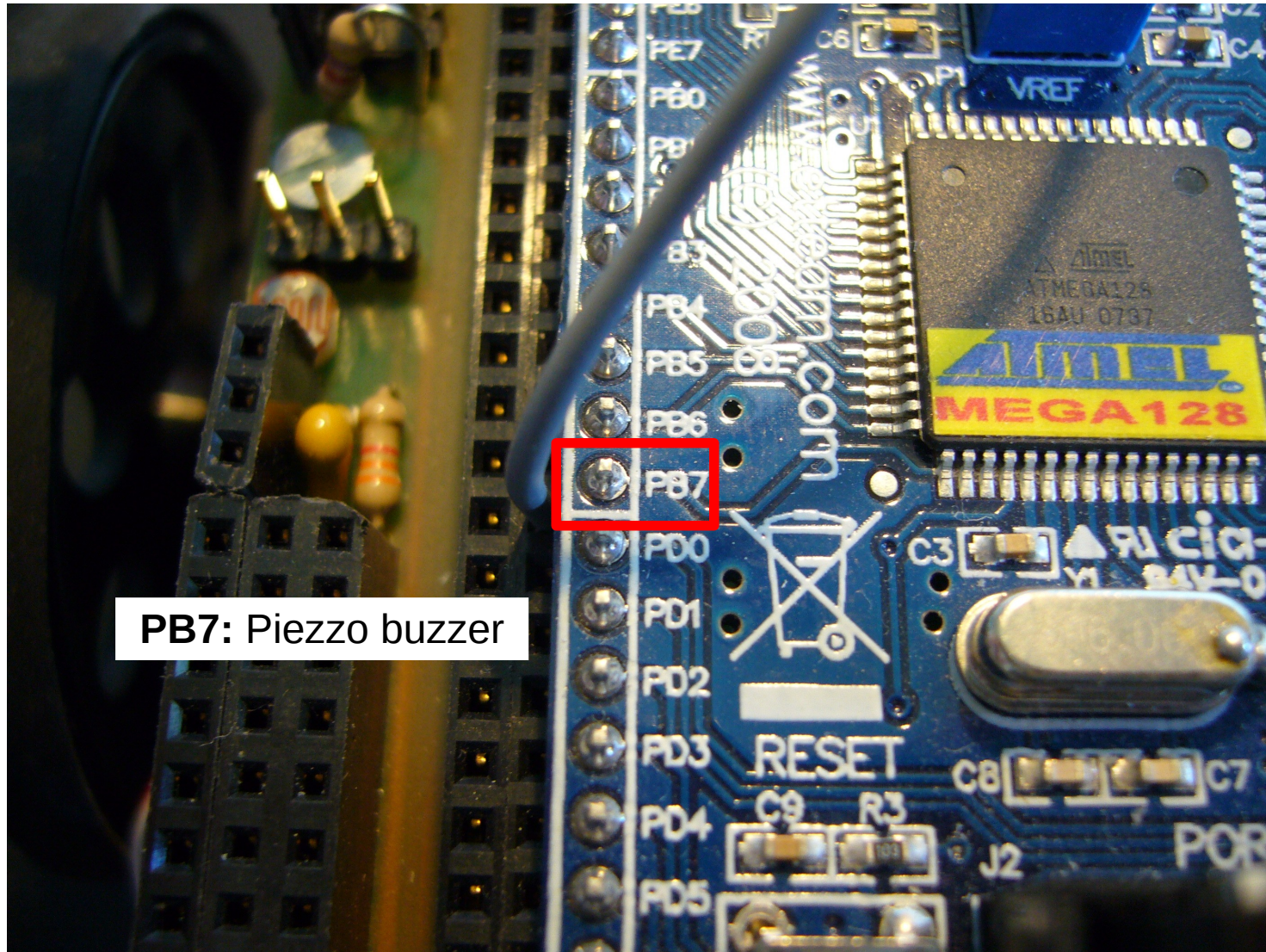

PB7: Piezzo buzzer

Pinout – Piezzo buzzer

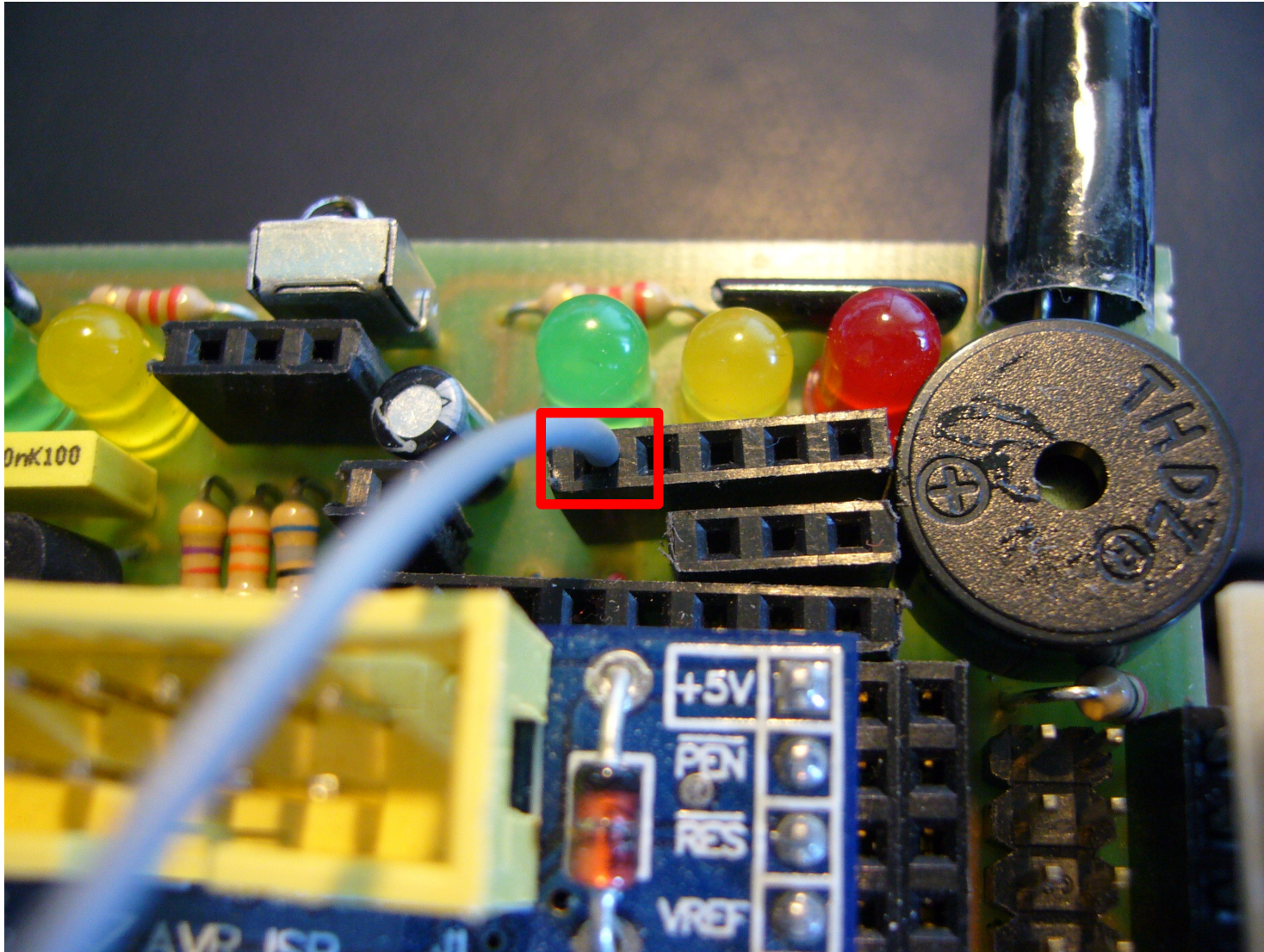

Pinout – Micròfon

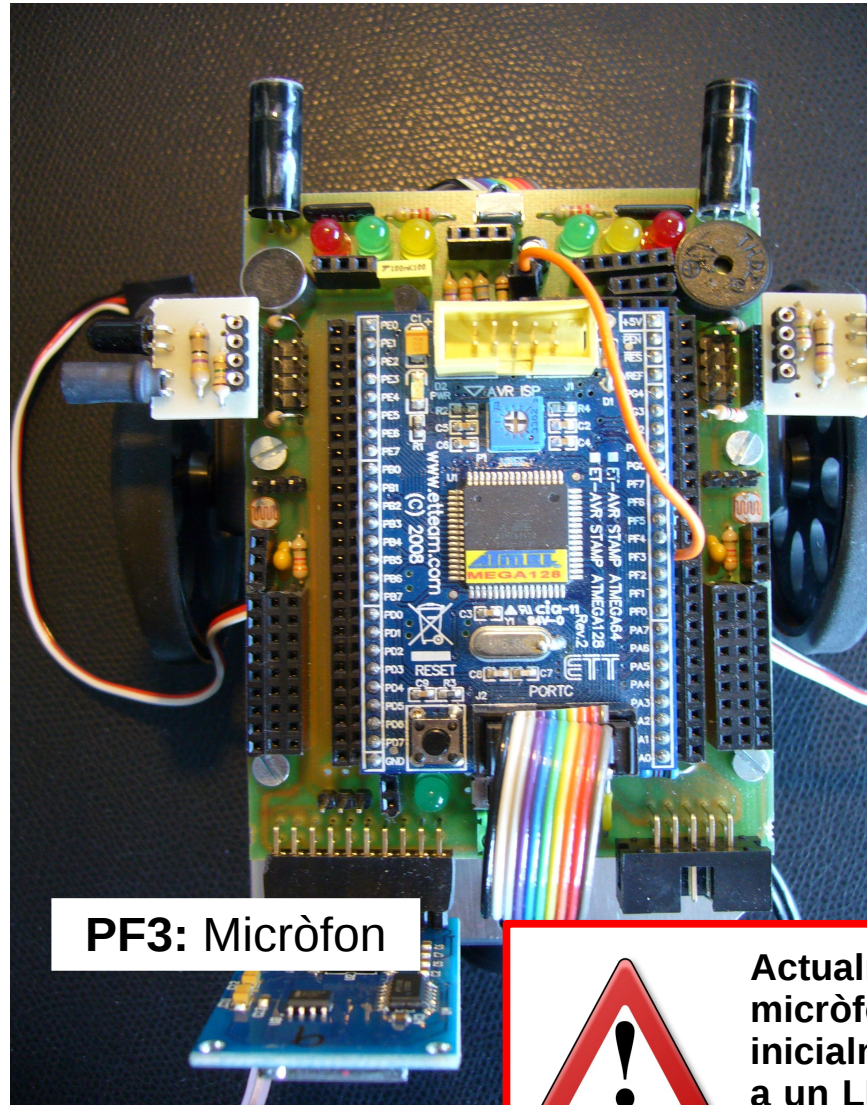

PF3: Micròfon



Actualment, el pin utilitzat pel micròfon és un pin que inicialment havia estat assignant a un LDR (LDR Left). Així doncs, LDR Left queda inoperatiu.

Pinout – Micròfon

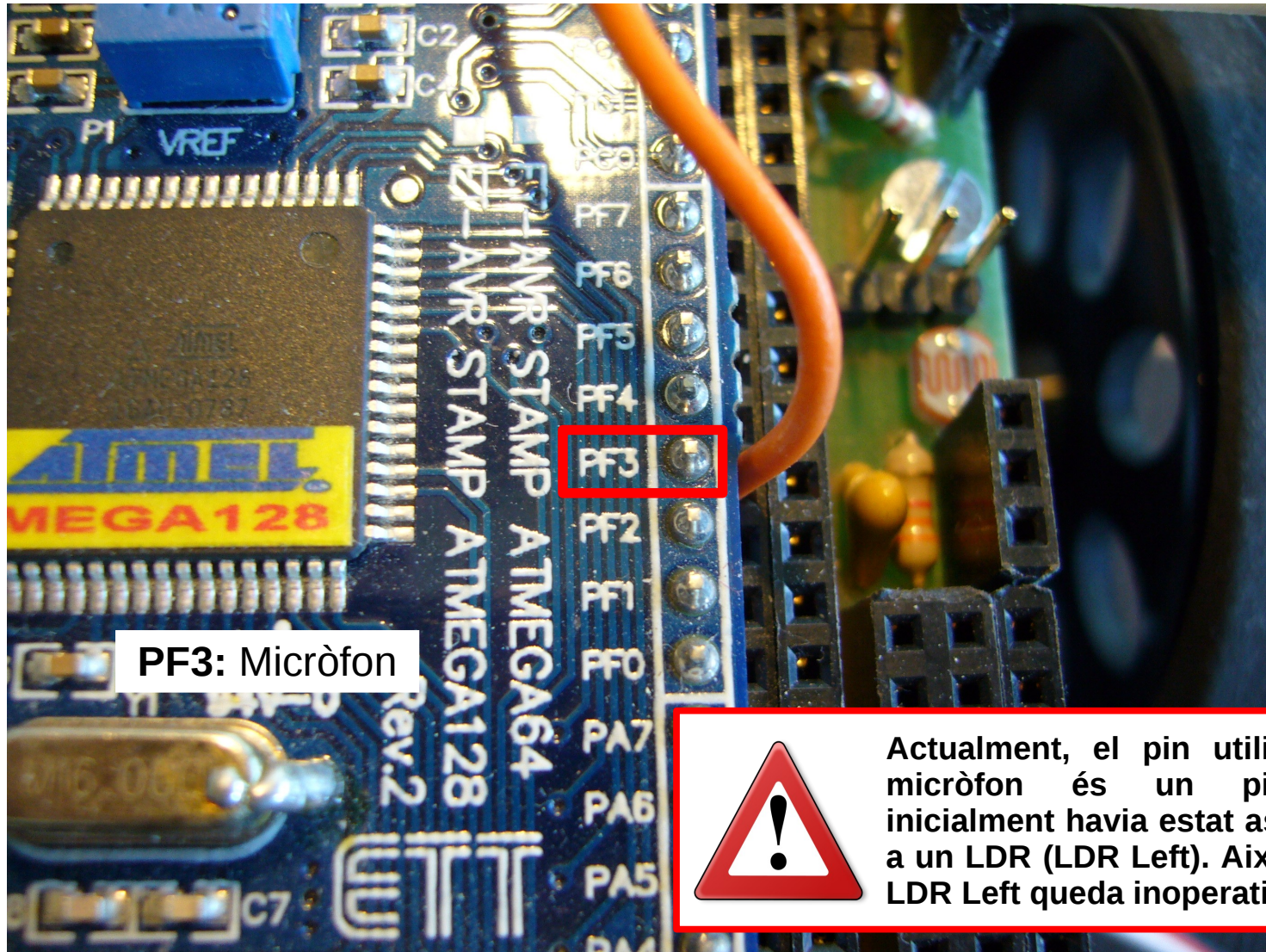

PF3: Micròfon



Actualment, el pin utilitzat pel micròfon és un pin que inicialment havia estat assignant a un LDR (LDR Left). Així doncs, LDR Left queda inoperatiu.

Pinout – Micròfon

